

# Straight Flat End Pull Handle

## AB3300, AB3301, AB3302

### Models :

- AB3300 - 1.00" Diameter
- AB3301 - 1.25" Diameter
- AB3302 - 1.50" Diameter

### Length Options:

- 12" - 120" Lengths Available
- MP - Mid Post Req. starting at 73" - 120"

### Finishes:

- US3, US32, US32D, US4, US9, US10, US10B
- Black Powder
- White Powder
- \* Custom Powder Coating Available

### Mounting Options:

- BTB - Back-to-Back Heavy Duty (Wood or Metal)
  - Heavy Duty (Glass)
- S - Single Side Mounting
  - Thru Bolt Heavy Duty (Wood or Metal)
  - Decorative Thru Bolt Heavy Duty (Glass)
  - Surface Concealed Heavy Duty (Metal)

### Engraving Options:

- BTB - Push/Pull
  - Push
  - Pull
- Single Side Only
  - Push
  - Pull

### Door Options:

- Glass, Wood, or Metal
- Door Thickness
  - 1/2"
  - 1-3/4"
  - 2-1/4"

\* Custom Door Thickness Available

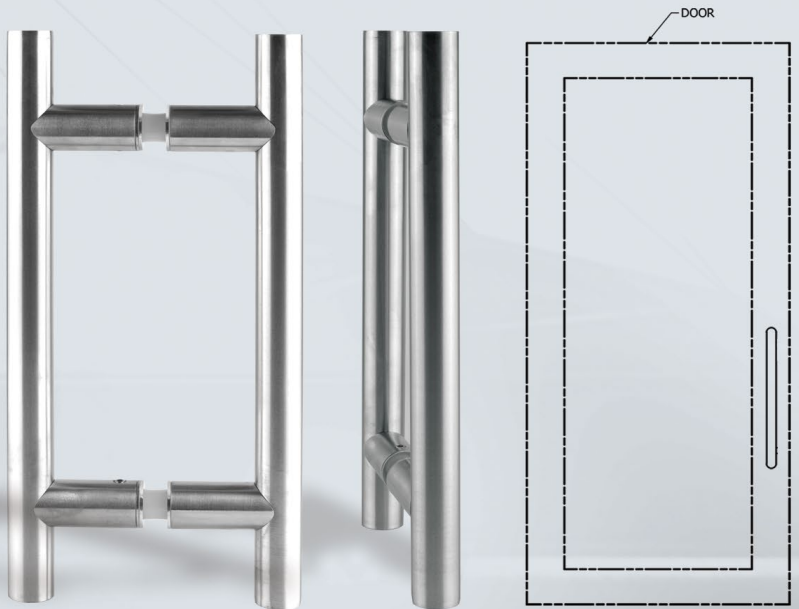

BTB - Shown

**Mounting Options:** Go to [www.abhmfg.com](http://www.abhmfg.com) for more mounting information

### Thru Bolt - Type 1HD

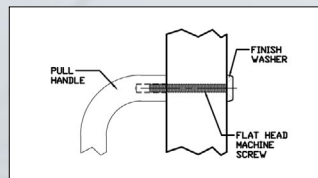

### Thru Bolt - Type 12HD

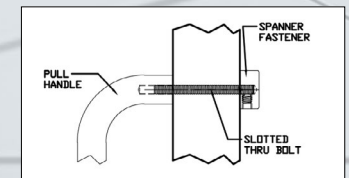

### Concealed - Type 6HD

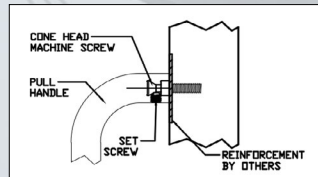

### Concealed - Type 8HD

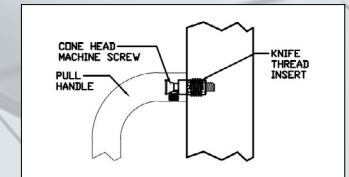

### Back-to-Back - Type 5HD

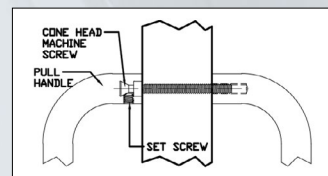

### Glass Door Thru Bolt Type 15HD

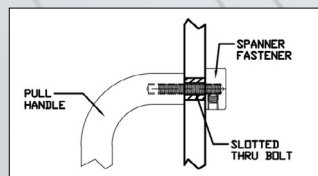

### Glass Door Back-to-Back Type 13HD

