

**A150HD - "EA" & "R" OPTION, KAWNEER, EASY ACCESS WITH REMOVABLE OPTION,  
CONCEALED ELECTRIFICATION, FULL CONCEALED, ALUMINUM GEARED HINGE**

**79"**

**83"**

**\*85"**

**\*95"**

**120"**

NON-HANDED

NON-HANDED

NON-HANDED

NON-HANDED

NON-HANDED

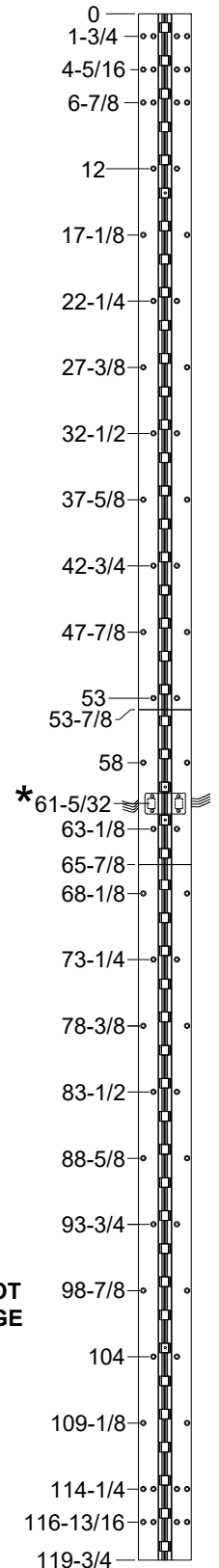
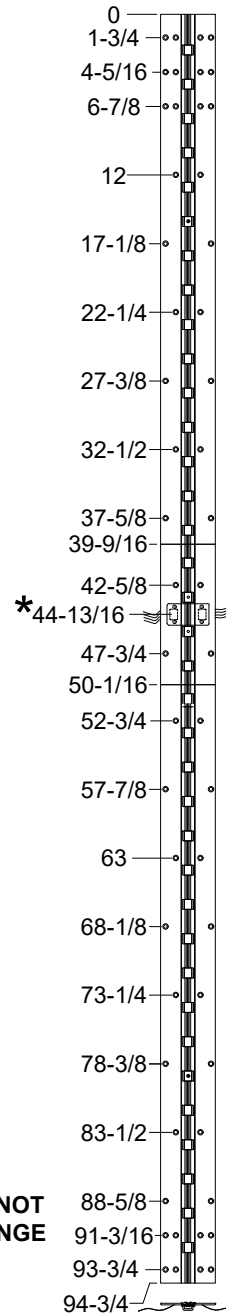
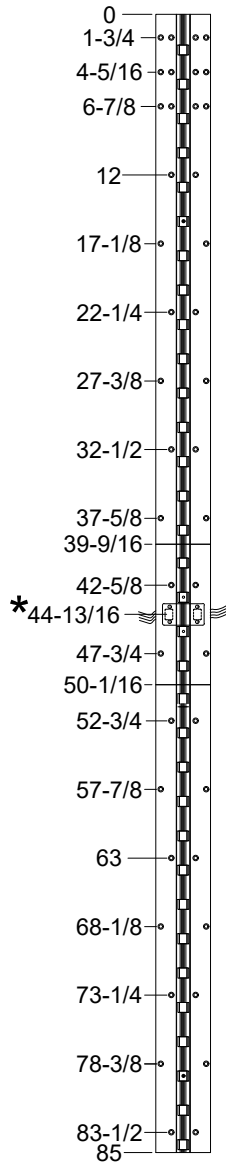
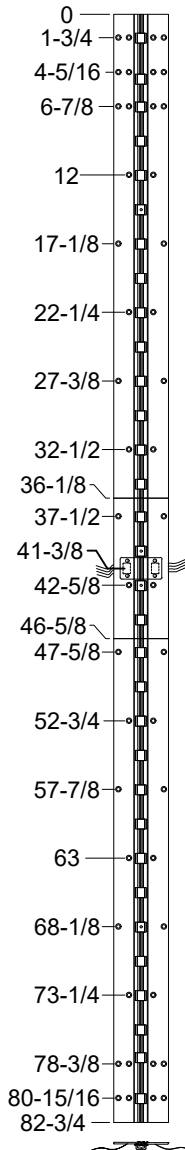
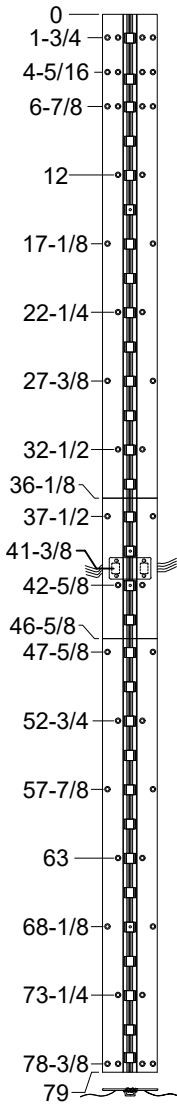

**12 WIRE STANDARD**

\*THE THRU WIRING IS NOT CENTERED IN THE HINGE

\*THE THRU WIRING IS NOT CENTERED IN THE HINGE

**NOTES:**

- 1. HINGES CUT TO CUSTOM LENGTH ARE CUT FROM BOTTOM OF HINGE. CUSTOM CUT HINGE REQUIRES HANDING.



R = REMOVABLE, (3) INDIVIDUAL HINGES, THRU WIRE CAN BE REMOVED TO ACCESS WIRES.

**STANDARD HINGE SIZES & SCREW DETAIL**

NOMINAL DOOR HEIGHT		6'8"	7'0"	7'2"	8'0"	10'0"
ACTUAL HINGE LENGTH		79"	83"	85"	95"	120"
FRAME	12-24 x 7/8" PHILLIPS FLAT HEAD, UNDERCUT, SELF DRILLING, THREAD FORMING TEK MACHINE SCREW	21	23	21	26	30
DOOR	12-24 x 7/8" PHILLIPS FLAT HEAD, UNDERCUT, SELF DRILLING, THREAD FORMING TEK MACHINE SCREW	21	23	21	26	30

\*THE THRU WIRING IS NOT CENTERED IN THE HINGE

A150HD- EA & R, ELECTRICAL MODIFICATION WITH REMOVABLE OPTION-1-02



www.abhmfg.com  
E-mail: abhinfo@abhmfg.com  
Architectural Builders Hardware Mfg., Inc.  
1222 Ardmore Ave., Itasca, IL 60143  
630.875.9900; FAX 800.9FAXABH (932.9224)

©2020 ABH Mfg., Inc.  
printed in USA

**A150HD - "EA" & "R"**  
ELECTRICAL MODIFICATION  
WITH REMOVABLE OPTION  
PAGE 1 OF 2  
ISSUED 05-05-20

**A150HD - "EA" & "R" OPTION, KAWNEER, EASY ACCESS WITH REMOVABLE OPTION, CONCEALED ELECTRIFICATION, FULL CONCEALED, ALUMINUM GEARED HINGE**

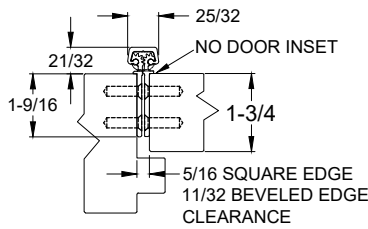
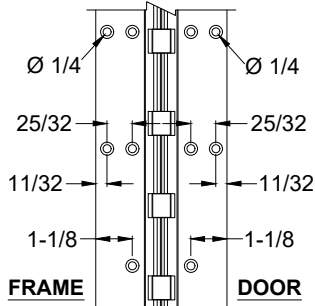

**CLOSED POSITION**

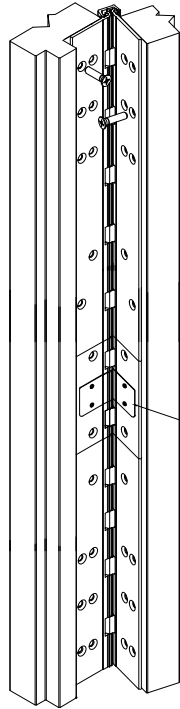

**ISOMETRIC VIEW  
~90° OPENING**

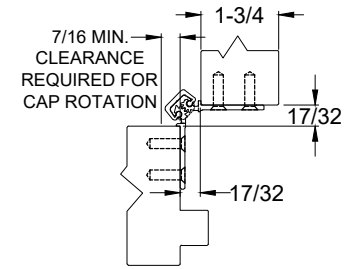

**90° OPENING**

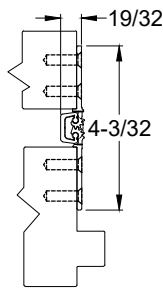

**180° OPENING**

#6 SPANNER FLAT HEAD SECURITY SCREW PROVIDED STANDARD (4 PLACES)

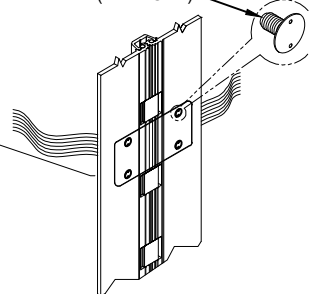

**ISOMETRIC VIEW  
180° OPENING**

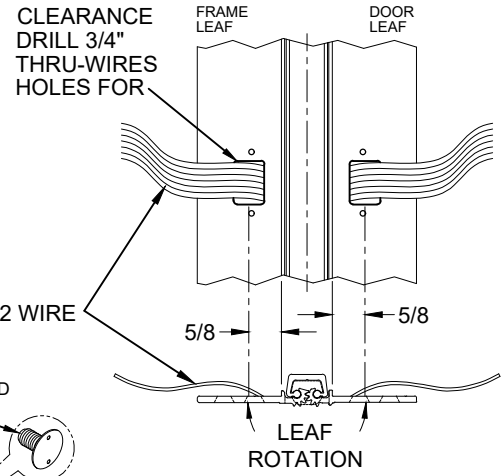

**WIRE TRANSFER VIEW**

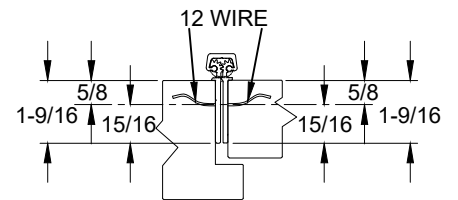

**WIRE TRANSFER VIEW**

**NOTES:**

1. MOLEX CONNECTOR OPTION AVAILABLE - SUFFIX "EZ".

\* SPECIFY ELECTRIFIED HARDWARE MANUFACTURER FOR CONNECTOR COMPABILITY

**EZ CONNECT OPTION**

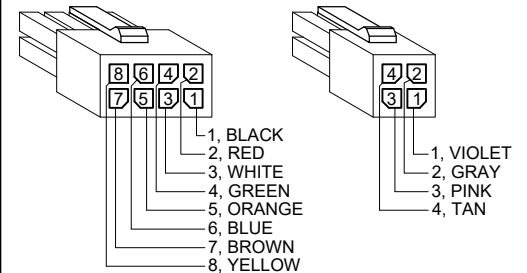

**SPECIFICATION:**

**DESCRIPTION:** SINGLE CONDUCTOR #22 AWG MINIATURE HOOK-UP WIRE FOR APPLICATIONS REQUIRING EXTREME FLEXIBILITY.

**CONDUCTOR:** #22 AWG 168/44 (0.002") SOFT BARE COPPER LHL.

**INSULATION:** PROPRIETARY FORMULATION PVC 0.010" NOM. WALL MEETS VW-1 FLAME REQUIREMENT.

**DIAMETER:** 0.053" ± 0.003".

**RESISTANCE:** 16.7 OHMS MAX. @ 20°C, PER 1000 FT.

**VOLTAGE RATING:** 600 VOLTS RMS, DEPENDING ON SPECIFICATION.

**AVAILABLE AS RoHS COMPLIANT.**

A150HD- EA & R, ELECTRICAL MODIFICATION WITH REMOVABLE OPTION-2-02



www.abhmfg.com  
E-mail: abhinfo@abhmfg.com  
Architectural Builders Hardware Mfg., Inc.  
1222 Ardmore Ave., Itasca, IL 60143  
630.875.9900; FAX 800.9FAXABH (932.9224)

© 2020 ABH Mfg., Inc.  
printed in USA

**A150HD - "EA" & "R"**  
ELECTRICAL MODIFICATION  
WITH REMOVABLE OPTION  
PAGE 2 OF 2  
ISSUED 05-05-20