

A111HD - "EA" & "R" ELECTRICAL MODIFICATION WITH REMOVABLE OPTION

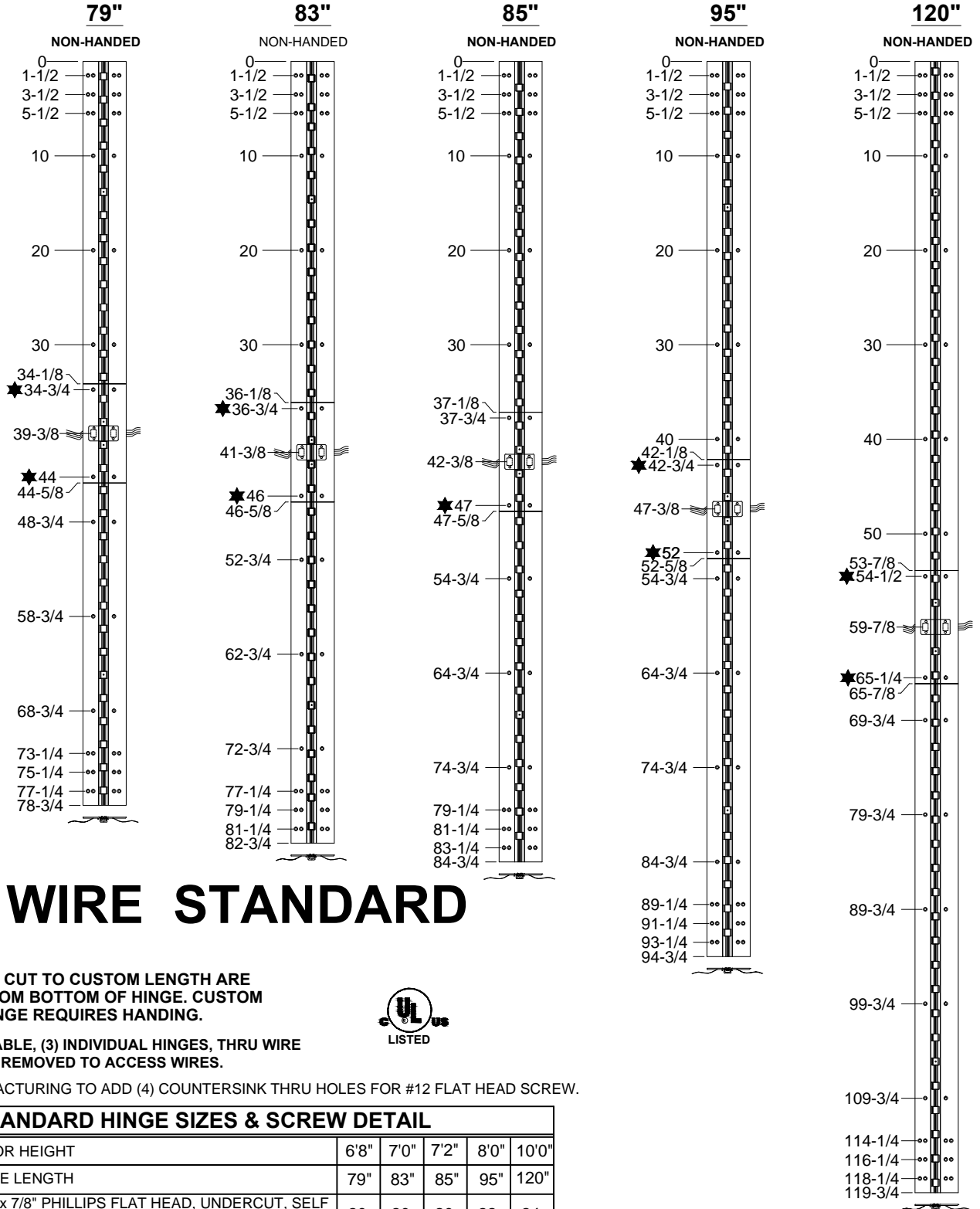

12 WIRE STANDARD

NOTES:

1. HINGES CUT TO CUSTOM LENGTH ARE CUT FROM BOTTOM OF HINGE. CUSTOM CUT HINGE REQUIRES HANDING.

R = REMOVABLE, (3) INDIVIDUAL HINGES, THRU WIRE CAN BE REMOVED TO ACCESS WIRES.

★ = MANUFACTURING TO ADD (4) COUNTERSINK THRU HOLES FOR #12 FLAT HEAD SCREW.



STANDARD HINGE SIZES & SCREW DETAIL

NOMINAL DOOR HEIGHT		6'8"	7'0"	7'2"	8'0"	10'0"
ACTUAL HINGE LENGTH		79"	83"	85"	95"	120"
FRAME	12-24 x 7/8" PHILLIPS FLAT HEAD, UNDERCUT, SELF DRILLING, THREAD FORMING TEK MACHINE SCREW	20	20	20	22	24
DOOR	12-24 x 7/8" PHILLIPS FLAT HEAD, UNDERCUT, SELF DRILLING, THREAD FORMING TEK MACHINE SCREW	20	20	20	22	24

A111HD-EA & R, ELECTRICAL MODIFICATION WITH REMOVABLE OPTION -1-00.DWG



www.abhmfg.com
 E-mail: abhinfo@abhmfg.com
 Architectural Builders Hardware Mfg., Inc.
 1222 Ardmore Ave., Itasca, IL 60143
 630.875.9900; FAX 800.9FAXABH (932.9224)

© 2019 ABH Mfg., Inc.
 printed in USA

A111HD - "EA" & "R"
 ELECTRICAL MODIFICATION
 WITH REMOVABLE OPTION

A111HD - "EA" & "R" ELECTRICAL MODIFICATION WITH REMOVABLE OPTION

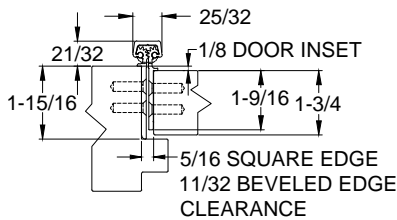
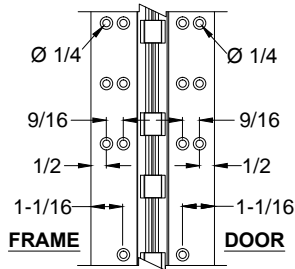

CLOSED POSITION

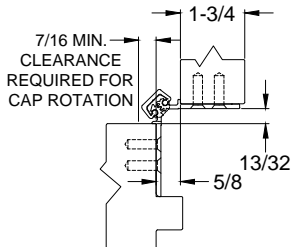

90° OPENING

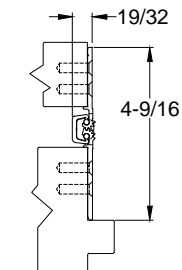

180° OPENING

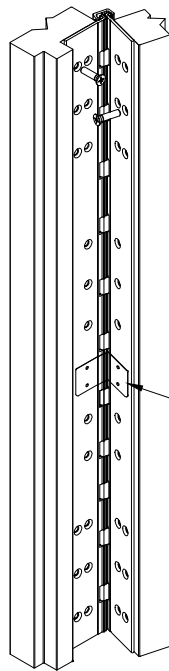

**ISOMETRIC VIEW
-180° OPENING**

#6 SPANNER FLAT HEAD SECURITY SCREW PROVIDED STANDARD (4 PLACES)

**ISOMETRIC VIEW
180° OPENING**

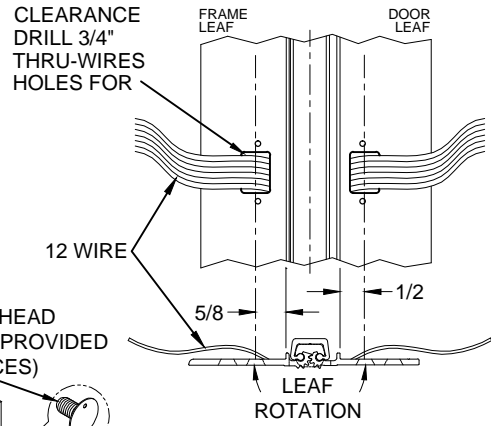

WIRE TRANSFER VIEW

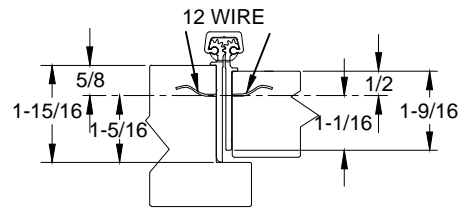

WIRE TRANSFER VIEW

NOTES:

1. MOLEX CONNECTOR OPTION AVAILABLE - SUFFIX "EZ".

* SPECIFY ELECTRIFIED HARDWARE MANUFACTURER FOR CONNECTOR COMPABILITY

EZ CONNECT OPTION

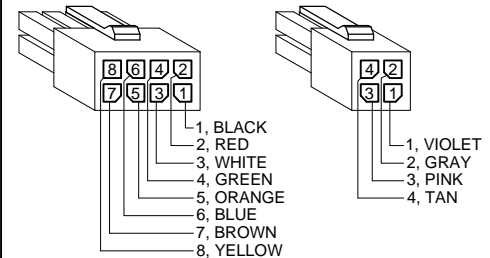

SPECIFICATION:

DESCRIPTION: SINGLE CONDUCTOR #22 AWG MINIATURE HOOK-UP WIRE FOR APPLICATIONS REQUIRING EXTREME FLEXIBILITY.

CONDUCTOR: #22 AWG 168/44 (0.002") SOFT BARE COPPER LHL.

INSULATION: PROPRIETARY FORMULATION PVC 0.010" NOM. WALL MEETS VW-1 FLAME REQUIREMENT.

DIAMETER: 0.053" ± 0.003".

RESISTANCE: 16.7 OHMS MAX. @ 20°C, PER 1000 FT.

VOLTAGE RATING: 600 VOLTS RMS, DEPENDING ON SPECIFICATION.

AVAILABLE AS RoHS COMPLIANT.

A111HD-EA & R, ELECTRICAL MODIFICATION WITH REMOVABLE OPTION -2-00.DWG