

**A111HD - "EA" OPTION, EASY ACCESS CONCEALED ELECTRIFICATION,
ALUMINUM GEARED HINGE**

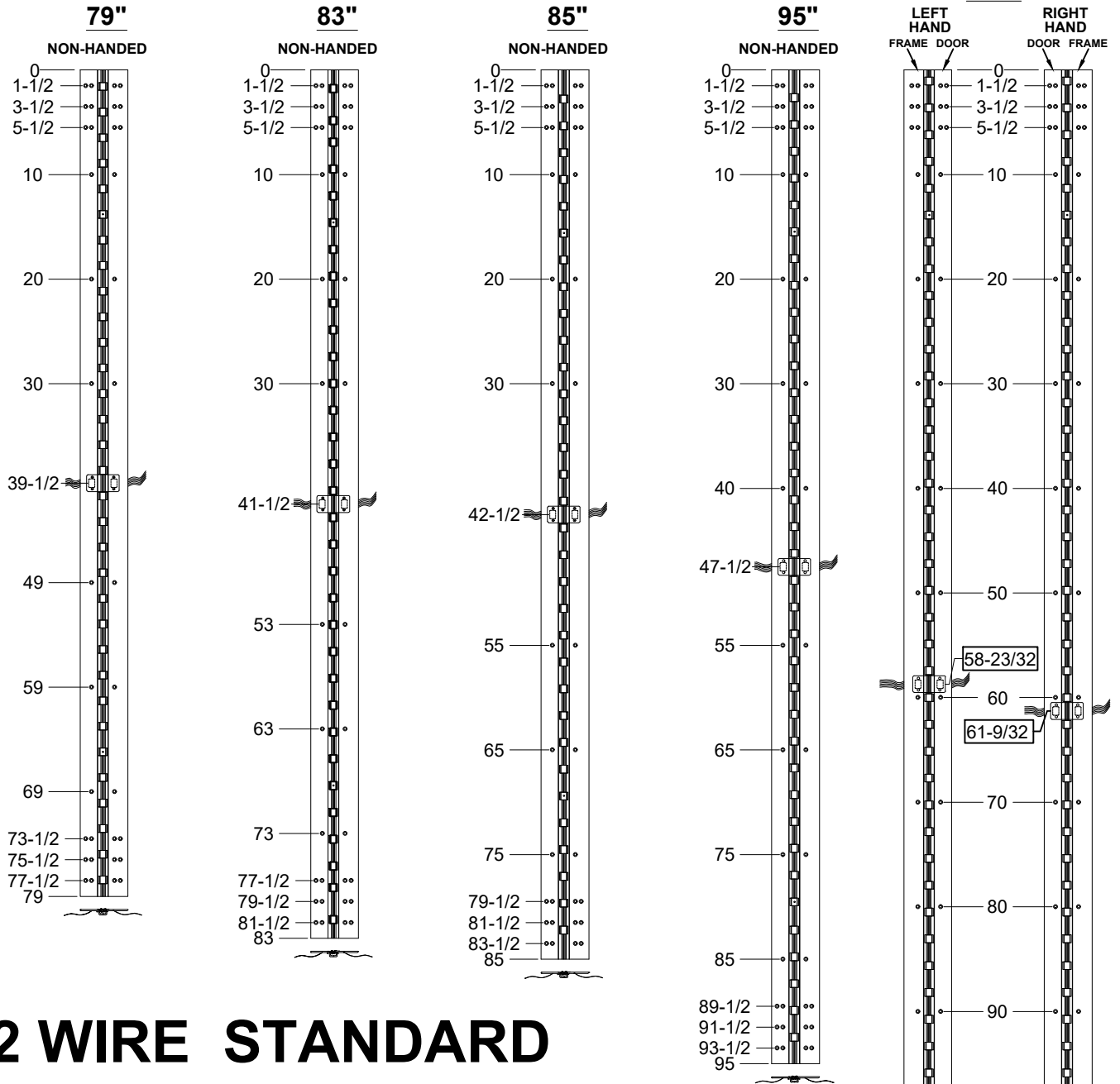

12 WIRE STANDARD

NOTES:

- 1. HINGES CUT TO CUSTOM LENGTH ARE CUT FROM BOTTOM OF HINGE. CUSTOM CUT HINGE REQUIRES HANDING.



STANDARD HINGE SIZES & SCREW DETAIL

		6'8"	7'0"	7'2"	8'0"	10'0"
NOMINAL DOOR HEIGHT		6'8"	7'0"	7'2"	8'0"	10'0"
ACTUAL HINGE LENGTH		79"	83"	85"	95"	120"
FRAME	12-24 x 3/4" PHILLIPS FLAT HEAD, UNDERCUT, SELF DRILLING, THREAD FORMING TEK MACHINE SCREW	18	18	18	20	23
DOOR	12-24 x 3/4" PHILLIPS FLAT HEAD, UNDERCUT, SELF DRILLING, THREAD FORMING TEK MACHINE SCREW	18	18	18	20	23

A111HD-EA OPTION, EASY ACCESS CONCEALED ELECTRIFICATION-1-03.DWG



www.abhmf.com
 E-mail: abhinfo@abhmf.com
 Architectural Builders Hardware Mfg., Inc.
 1222 Ardmore Ave., Itasca, IL 60143
 630.875.9900; FAX 800.9FAXABH (932.9224)

**A111HD - "EA" OPTION EASY ACCESS
CONCEALED ELECTRIFICATION**

© 2020 ABH Mfg., Inc.
printed in USA

PAGE 1 OF 2
REVISED 10-28-20

**A111HD - "EA" OPTION, EASY ACCESS CONCEALED ELECTRIFICATION,
ALUMINUM GEARED HINGE**

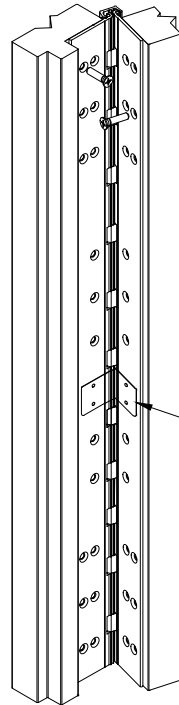
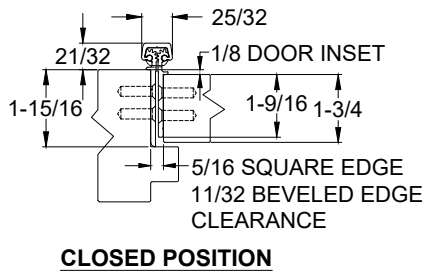
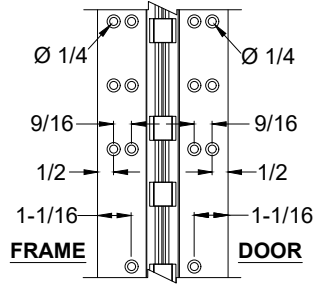

#6 SPANNER FLAT HEAD SECURITY SCREW PROVIDED STANDARD (4 PLACES)

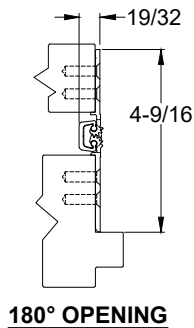
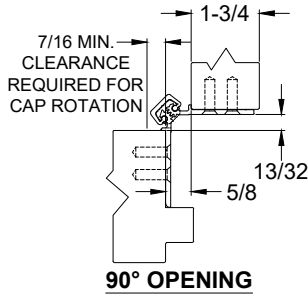
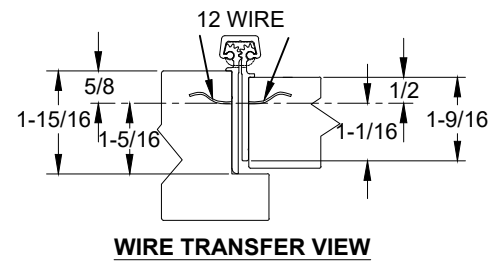
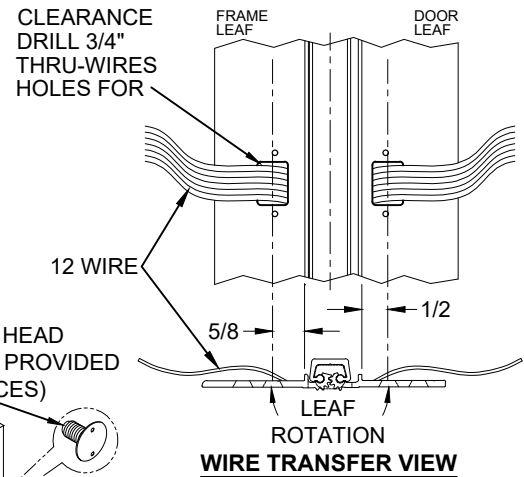
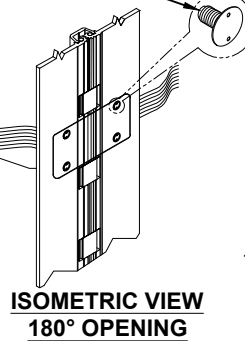

NOTES:

1. MOLEX CONNECTOR OPTION AVAILABLE - SUFFIX "EZ".
* SPECIFY ELECTRIFIED HARDWARE MANUFACTURER FOR CONNECTOR COMPABILITY

EZ CONNECT OPTION

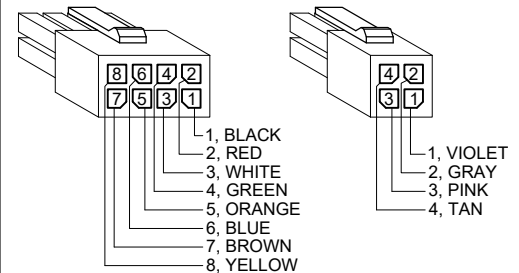

SPECIFICATION:

DESCRIPTION: SINGLE CONDUCTOR #22 AWG MINIATURE HOOK-UP WIRE FOR APPLICATIONS REQUIRING EXTREME FLEXIBILITY.
CONDUCTOR: #22 AWG 168/44 (0.002") SOFT BARE COPPER LHL.
INSULATION: PROPRIETARY FORMULATION PVC 0.010" NOM. WALL MEETS VW-1 FLAME REQUIREMENT.
DIAMETER: 0.053" ± 0.003".
RESISTANCE: 16.7 OHMS MAX. @ 20°C, PER 1000 FT.
VOLTAGE RATING: 600 VOLTS RMS, DEPENDING ON SPECIFICATION.
AVAILABLE AS RoHS COMPLIANT.



www.abhmfg.com
E-mail: abhinfo@abhmfg.com
Architectural Builders Hardware Mfg., Inc.
1222 Ardmore Ave., Itasca, IL 60143
630.875.9900; FAX 800.9FAXABH (932.9224)

**A111HD - "EA" OPTION EASY ACCESS
CONCEALED ELECTRIFICATION**

© 2020 ABH Mfg., Inc.
printed in USA