

**A150HD - "ES" OPTION, KAWNEER, CONCEALED ELECTRIFICATION, FULL CONCEALED,
ALUMINUM GEARED HINGE**

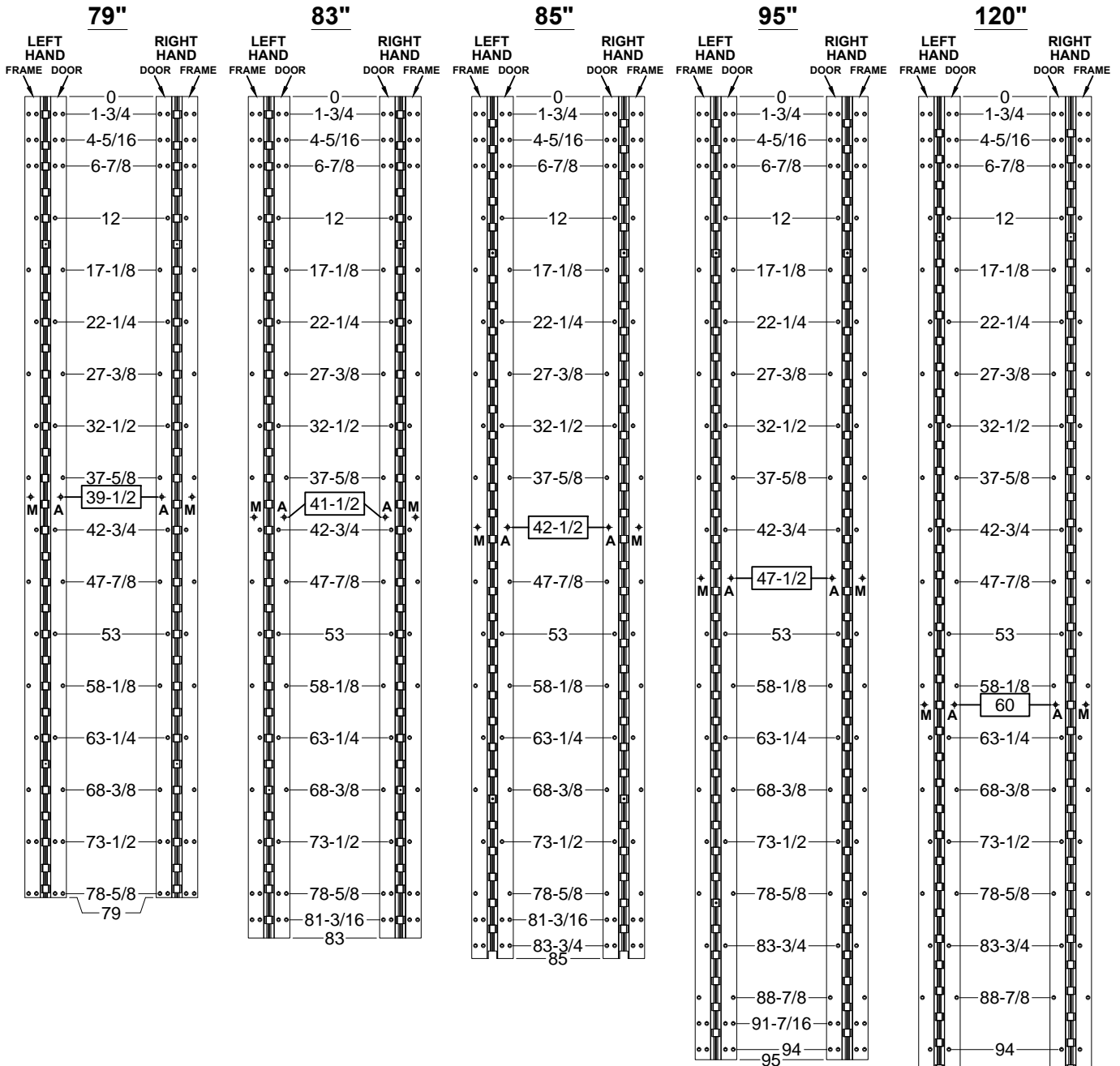

M = MONITOR SWITCH SIDE
A = ADJUSTMENT SCREW SIDE



STANDARD HINGE SIZES & SCREW DETAIL

NOMINAL DOOR HEIGHT	6'8"	7'0"	7'2"	8'0"	10'0"
ACTUAL HINGE LENGTH	79"	83"	85"	95"	120"
FRAME	12-24 x 7/8" PHILLIPS FLAT HEAD, UNDERCUT, SELF DRILLING, THREAD FORMING TEK MACHINE SCREW				
DOOR	12-24 X 7/8" PH. F.H. UNDERCUT SELF DRILLING THREAD FORMING TEK SCREW				
	22	23	23	25	30

A150HD-ES OPTION, CONCEALED ELECTRIFICATION-1-01



® www.abhmfg.com
E-mail: abhinfo@abhmfg.com
Architectural Builders Hardware Mfg., Inc.
1222 Ardmore Ave., Itasca, IL 60143
630.875.9900; FAX 800.9FAXABH (932.9224)

**A150HD - "ES" OPTION
CONCEALED ELECTRIFICATION**

© 2017 ABH Mfg., Inc.
printed in USA

PAGE 1 OF 2
ISSUED 06-13-17

**A150HD - "ES" OPTION, KAWNEER, CONCEALED ELECTRIFICATION, FULL CONCEALED,
ALUMINUM GEARED HINGE**

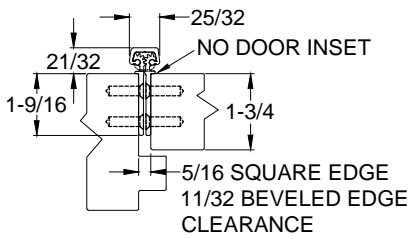

CLOSED POSITION

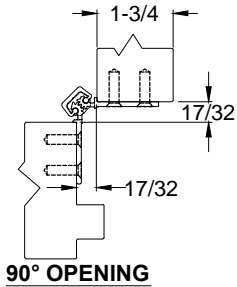

90° OPENING

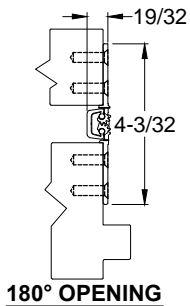

180° OPENING

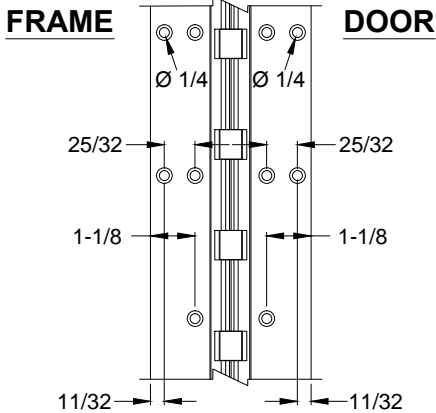
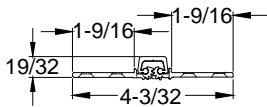

NOTES:

1. HINGES CUT TO CUSTOM LENGTH ARE CUT FROM BOTTOM OF HINGE.
2. SPECIFY HANDING WHEN ORDERING.
3. IF "M" OPTION (MOVEABLE PANEL) OR "R" OPTION (REMOVABLE PANEL) IS CHOSEN, TEMPLATE REMAINS THE SAME.

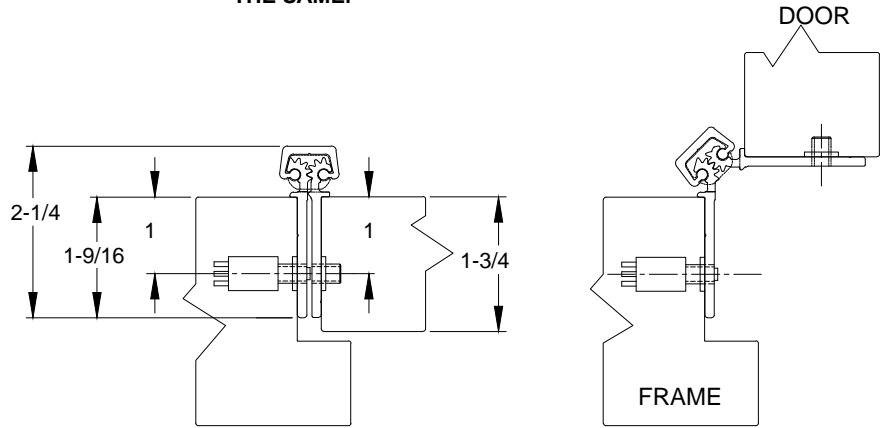

EXPOSED MONITOR SWITCH VIEW, LEFT HAND SHOWN

SWITCH SCHEMATIC

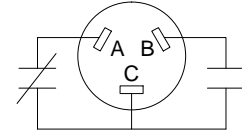

A & C = NORMALLY CLOSED
B & C = NORMALLY OPEN

NOTE: 5/8" DIA. HOLE REQUIRED IN JAMB FOR MONITORING SWITCH AND A 7/16" DIA. HOLE FOR CLEARANCE OF ADJUSTMENT SCREW

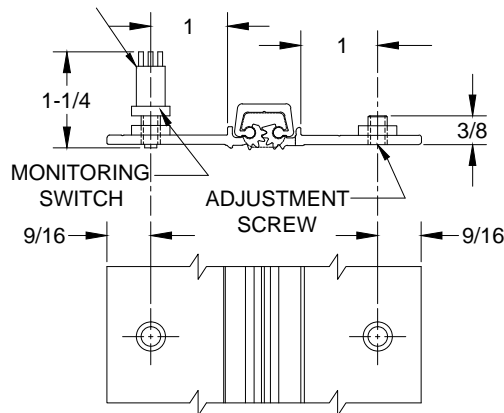

EXPOSED MONITOR SWITCH VIEW

