

CUSTOM SCR4590 DOUBLE-LIPPED STRIKE & RESCUE STOP COMBO

- 1-3/4" THICK DOOR
- CENTER HUNG DOOR
- SCHLAGE MORTISE LOCK W/ DEAD BOLT
- 9-7/8" FRAME

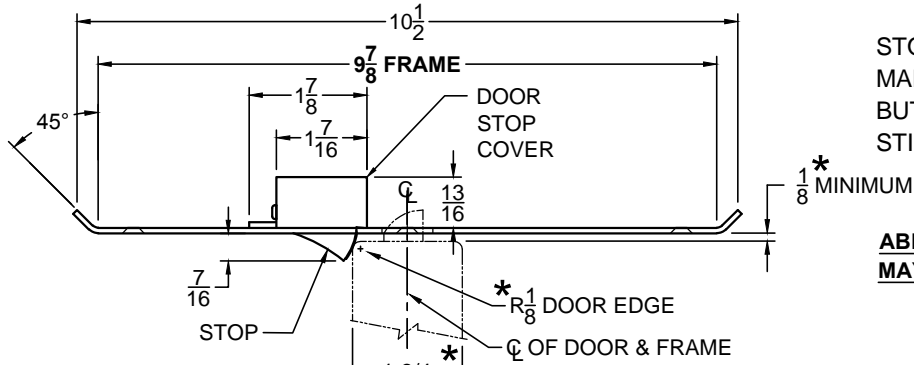

TOP VIEW

STOP IS SPRING LOADED
MAKING PART NON-HANDED
BUT INSTALLATION IS
STILL HANDED

**ABH DOOR STOP COVER DIMENSIONS
MAY NOT MATCH OTHER MANUFACTURERS**

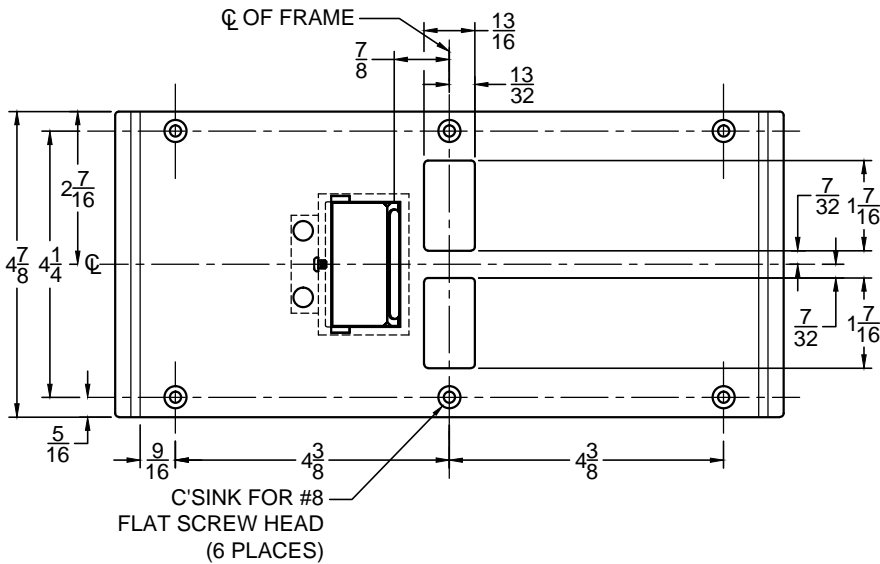

FRONT VIEW

2-5/16"
MIN. CLEARANCE
FOR DOOR STOP
CENTERED

3-7/16"
MIN. CLEARANCE
FOR DOOR STRIKE
CENTERED

(2) REINFORCEMENT
PLATES SUPPLIED BY
DOOR FRAME
MANUFACTURER

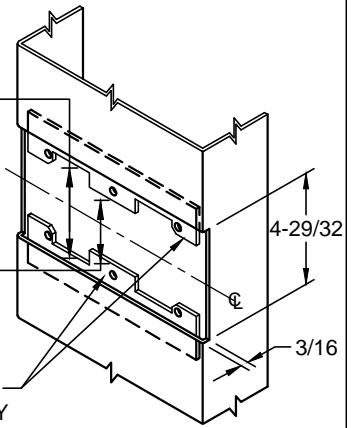

**CUT-OUT FOR
METAL JAMB**

NOTE:

1. HORIZONTAL CENTERLINE OF PLATE TO MATCH HORIZONTAL CENTERLINE OF CUT-OUT.
2. SCREWS- 8-32 X 3/8" UNDERCUT F.H.M.S.
3. R.H. DOOR SHOWN, L.H. OPPOSITE
4. DO NOT SCALE DRAWING.
5. FOR CUSTOM RESCUE DOOR STOP CONSULT FACTORY.

REINFORCEMENT:

WHEN INSTALLING IN METAL FRAME, REINFORCEMENT IS **NEEDED** WITH THIS PRODUCT, CUSTOMER OR MANUFACTURER TO SUPPLY FRAME REINFORCEMENT WITH LATCH BOLT CLEARANCE.

* = CRITICAL DIMENSION MUST BE FOLLOWED



www.abhmf.com
E-mail: abhinfo@abhmf.com
Architectural Builders Hardware Mfg., Inc.
1222 Ardmore Ave., Itasca, IL 60143
630.875.9900; FAX 800.9FAXABH (932.9224)

SP-CR4440 9.875x4.875 SCHLAGE.DWG

SP-CR4440

©2016 ABH Mfg., Inc.
printed in USA

REVISED 11-30-16