

# CUSTOM SCR4590 DOUBLE-LIPPED STRIKE & RESCUE STOP COMBO

- 1-3/4" THICK DOOR
- CENTER HUNG DOOR
- SCHLAGE MORTISE LOCK W/ DEAD BOLT
- 9-5/8" FRAME

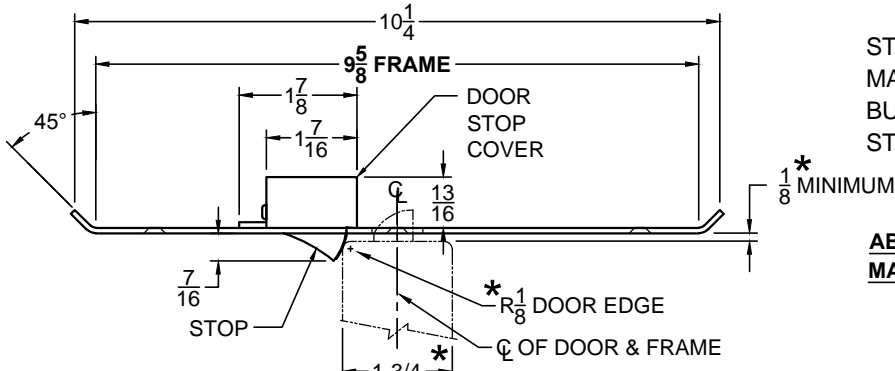

**TOP VIEW**

STOP IS SPRING LOADED  
MAKING PART NON-HANDED  
BUT INSTALLATION IS  
STILL HANDED

**ABH DOOR STOP COVER DIMENSIONS  
MAY NOT MATCH OTHER MANUFACTURERS**

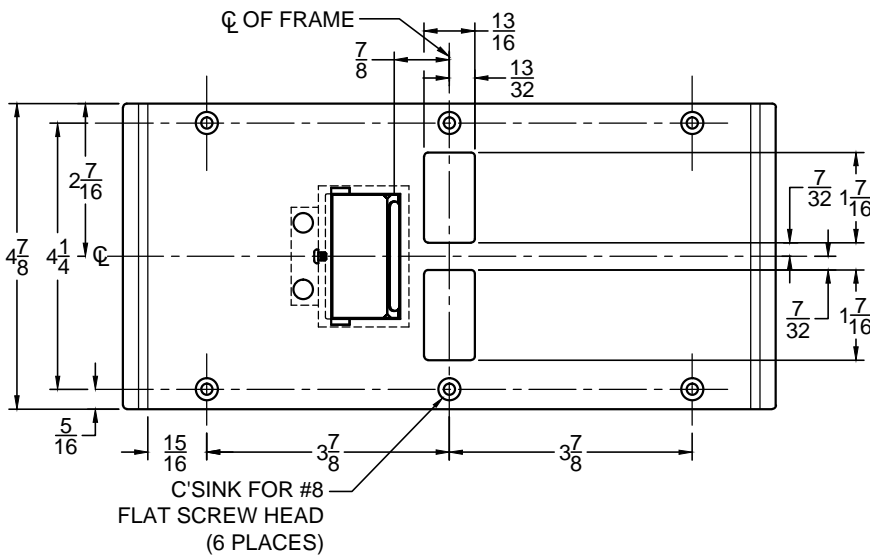

**FRONT VIEW**

2-5/16"  
MIN. CLEARANCE  
FOR DOOR STOP  
CENTERED

3-7/16"  
MIN. CLEARANCE  
FOR DOOR STRIKE  
CENTERED

(2) REINFORCEMENT  
PLATES SUPPLIED BY  
DOOR FRAME  
MANUFACTURER

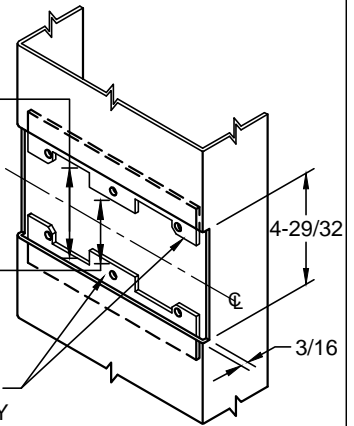

**CUT-OUT FOR  
METAL JAMB**

**NOTE:**

1. HORIZONTAL CENTERLINE OF PLATE TO MATCH HORIZONTAL CENTERLINE OF CUT-OUT.
2. SCREWS- 8-32 X 3/8" UNDERCUT F.H.M.S.
3. R.H. DOOR SHOWN, L.H. OPPOSITE
4. DO NOT SCALE DRAWING.
5. FOR CUSTOM RESCUE DOOR STOP CONSULT FACTORY.

**REINFORCEMENT:**

WHEN INSTALLING IN METAL FRAME, REINFORCEMENT IS **NEEDED** WITH THIS PRODUCT, CUSTOMER OR MANUFACTURER TO SUPPLY FRAME REINFORCEMENT WITH LATCH BOLT CLEARANCE.

\* = CRITICAL DIMENSION MUST BE FOLLOWED



www.abhmfg.com  
E-mail: abhinfo@abhmfg.com  
Architectural Builders Hardware Mfg., Inc.  
1222 Ardmore Ave., Itasca, IL 60143  
630.875.9900; FAX 800.9FAXABH (932.9224)

SP-CR4438 9.625x4.875 SCHLAGE.DWG

**SP-CR4438**

©2016 ABH Mfg., Inc.  
printed in USA

REVISED 11-30-16