

CUSTOM SDSM4500 DOUBLE-LIPPED STRIKE

- 1-3/4" THICK DOOR
- 1/8" INSET DOOR
- SCHLAGE MORTISE LOCK W / DEAD BOLT
- 6-5/8" FRAME

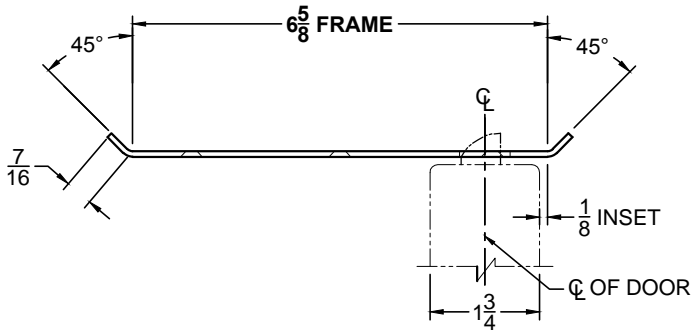

TOP VIEW

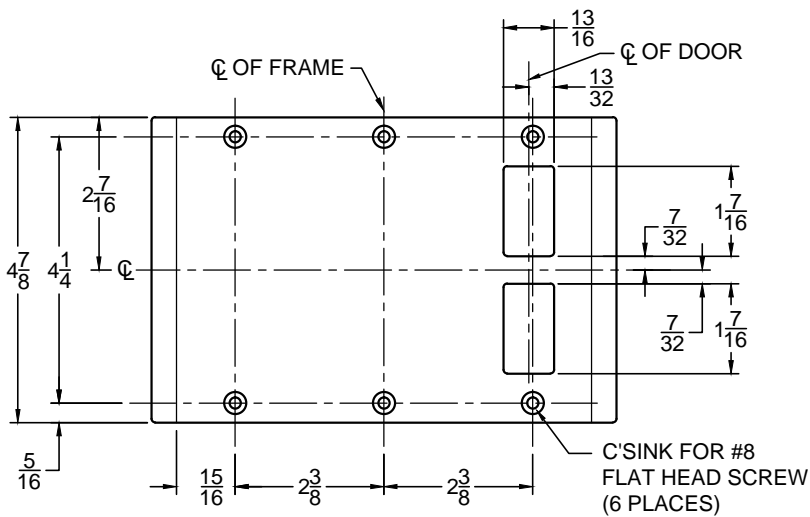

FRONT VIEW

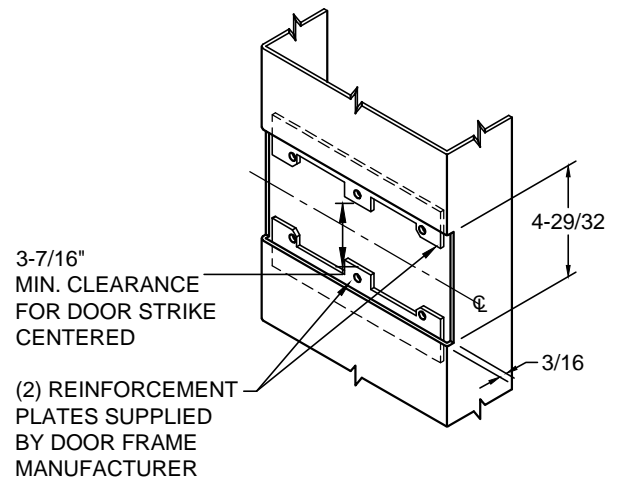

CUT-OUT FOR METAL JAMB

NOTE:

1. HORIZONTAL CENTERLINE OF PLATE TO MATCH HORIZONTAL CENTERLINE OF CUTOUT.
2. SCREWS- 8-32 X 3/8" UNDERCUT F.H.M.S.
3. R.H. DOOR SHOWN, L.H. OPPOSITE (DOUBLE-LIPPED STRIKE IS NON HANDED)
4. DO NOT SCALE DRAWING.
5. FOR CUSTOM STRIKE, CONSULT FACTORY.

REINFORCEMENT:

WHEN INSTALLING IN METAL FRAME, REINFORCEMENT IS **NEEDED** WITH THIS PRODUCT, CUSTOMER OR MANUFACTURER TO SUPPLY FRAME REINFORCEMENT WITH LATCH BOLT CLEARANCE.

SP-CR4699 6.625 x 4.875 SCHLAGE .DWG



www.abhmf.com
 E-mail: abhinfo@abhmf.com
 Architectural Builders Hardware Mfg., Inc.
 1222 Ardmore Ave., Itasca, IL 60143
 630.875.9900; FAX 800.9FAXABH (932.9224)

©2017 ABH Mfg., Inc.
 printed in USA

SP-CR4699

ISSUED 01-04-17