

## CUSTOM SDSM4500 DOUBLE-LIPPED STRIKE

- 1-3/4" THICK DOOR
- CENTER HUNG DOOR
- SCHLAGE MORTISE LOCK W / DEAD BOLT
- 8-5/8" FRAME

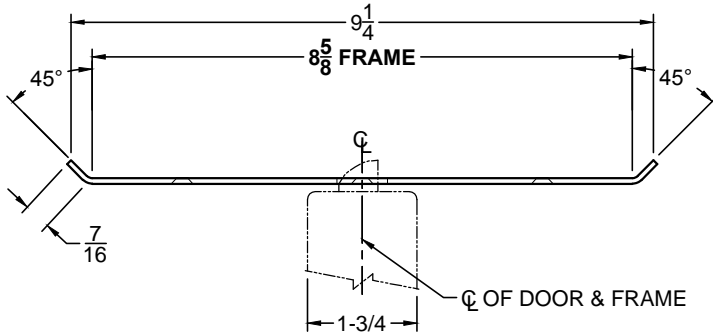

**TOP VIEW**

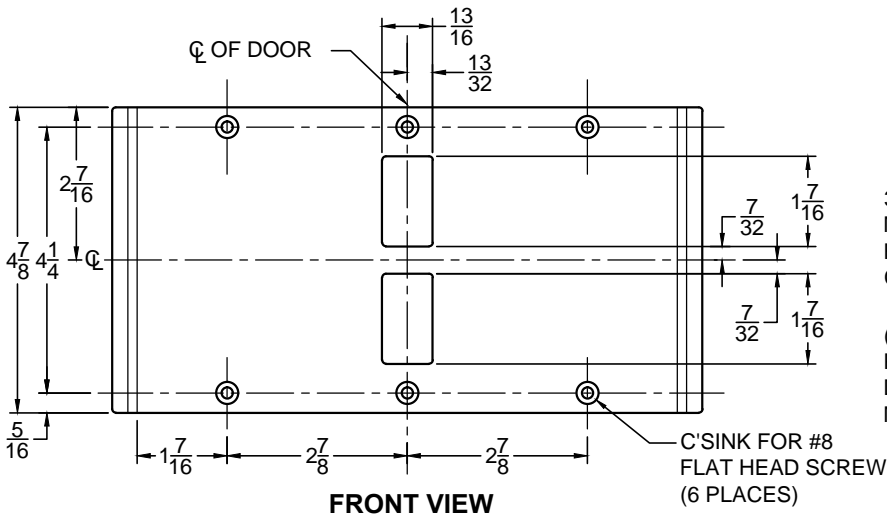

**FRONT VIEW**

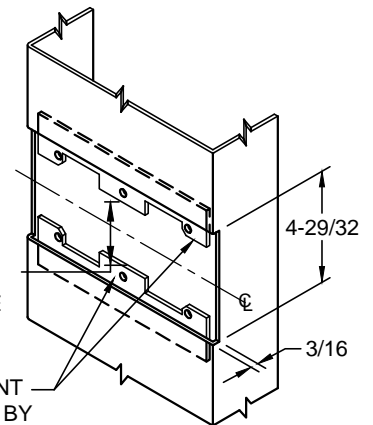

3-7/16"  
MIN. CLEARANCE  
FOR DOOR STRIKE  
CENTERED

(2) REINFORCEMENT  
PLATES SUPPLIED BY  
DOOR FRAME  
MANUFACTURER

**CUT-OUT FOR  
METAL JAMB**

**NOTE:**

1. HORIZONTAL CENTERLINE OF PLATE TO MATCH HORIZONTAL CENTERLINE OF CUTOUT.
2. SCREWS- 8-32 X 3/8" UNDERCUT F.H.M.S.
3. R.H. DOOR SHOWN, L.H. OPPOSITE (STRIKE IS NON HANDED)
4. DO NOT SCALE DRAWING.
5. FOR CUSTOM DOUBLE - LIPPED STRIKE CONSULT FACTORY.

**REINFORCEMENT:**

WHEN INSTALLING IN METAL FRAME, REINFORCEMENT IS **NEEDED** WITH THIS PRODUCT, CUSTOMER OR MANUFACTURER TO SUPPLY FRAME REINFORCEMENT WITH LATCH BOLT CLEARANCE.

SP-DS4678 8.625 x 4.875 SCHLAGE .DWG



www.abhmf.com  
E-mail: abhinfo@abhmf.com  
Architectural Builders Hardware Mfg., Inc.  
1222 Ardmore Ave., Itasca, IL 60143  
630.875.9900; FAX 800.9FAXABH (932.9224)

©2016 ABH Mfg., Inc.  
printed in USA

# SP-DS4678

ISSUED 12-30-16