

SP-CR1202 CUSTOM 4590 TYPE DOUBLE LIPPED STRIKE AND RESCUE STOP
 FOR 1-3/4" THICK, 1/8 INSET DOOR, MORTISE LOCK W/DEAD BOLT, 10-1/4" FRAME

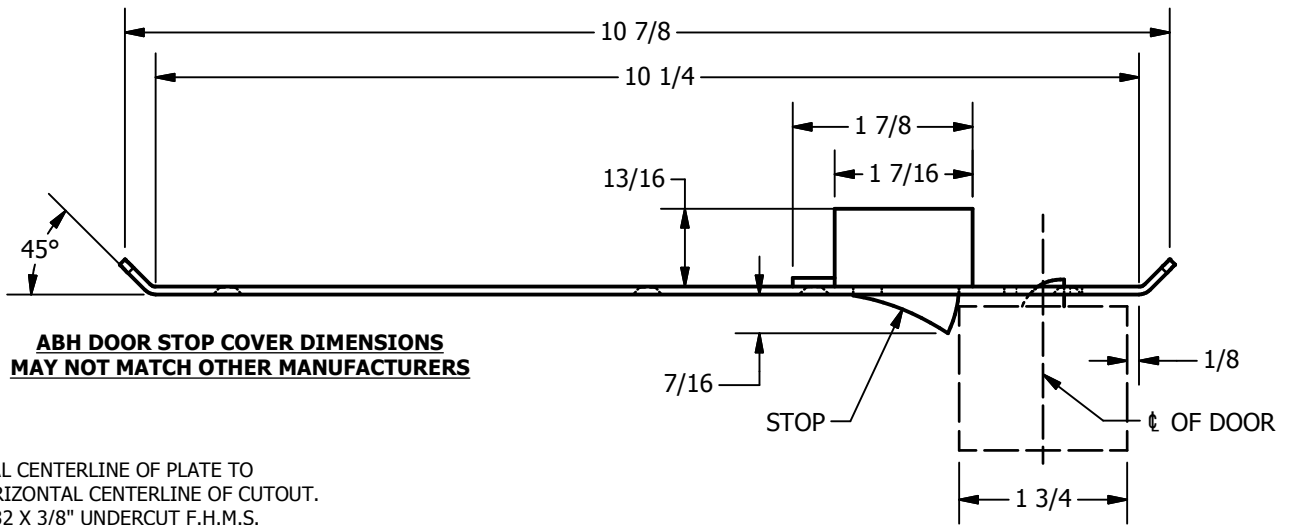

**ABH DOOR STOP COVER DIMENSIONS
 MAY NOT MATCH OTHER MANUFACTURERS**

- NOTE:
 1. HORIZONTAL CENTERLINE OF PLATE TO MATCH HORIZONTAL CENTERLINE OF CUTOUT.
 2. SCREWS 8-32 X 3/8" UNDERCUT F.H.M.S.
 3. R.H. DOOR SHOWN, L.H. OPPOSITE

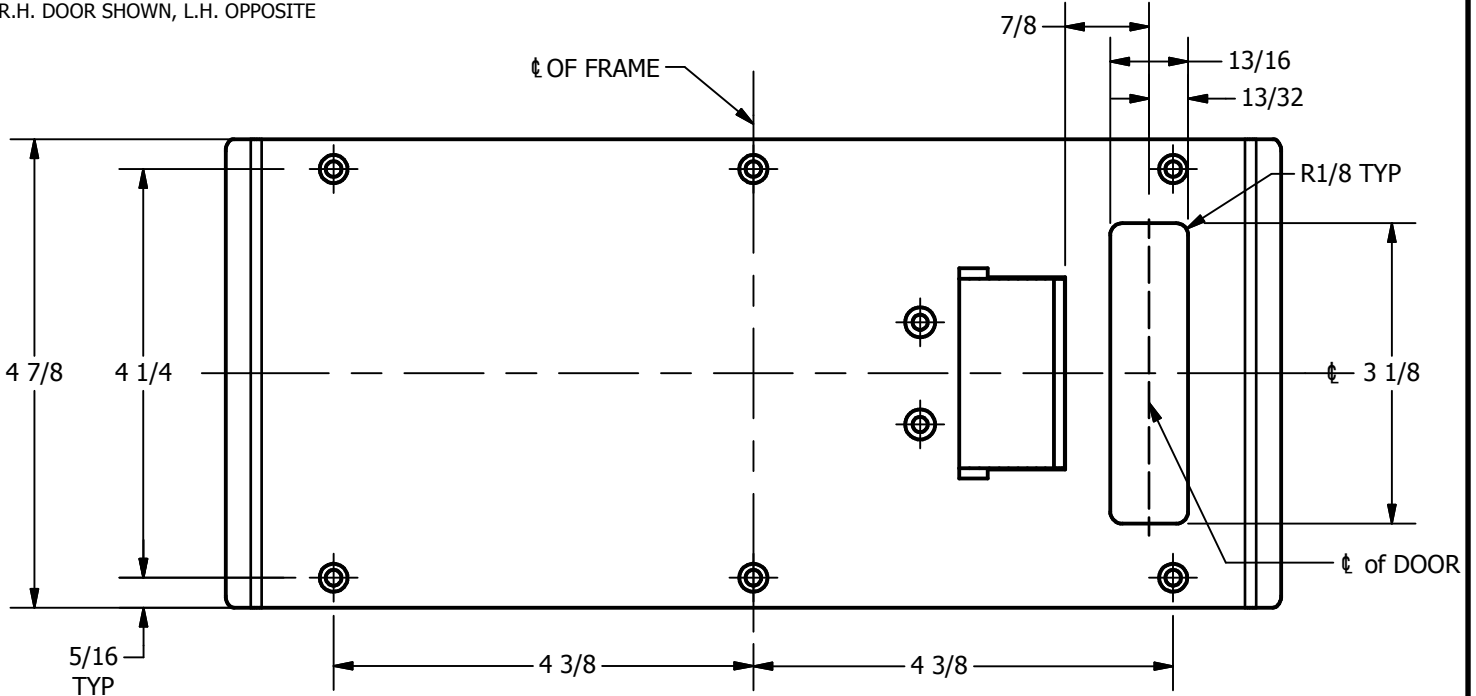

REINFORCEMENT:
 WHEN INSTALLING IN METAL FRAME, REINFORCEMENT IS **NEEDED** WITH THIS PRODUCT, CUSTOMER OR FRAME MANUFACTURER TO SUPPLY FRAME REINFORCEMENT WITH LATCH BOLT CLEARANCE

2-5/16
 MIN. CLEARANCE
 FOR DOOR STOP COVER
 CENTERED

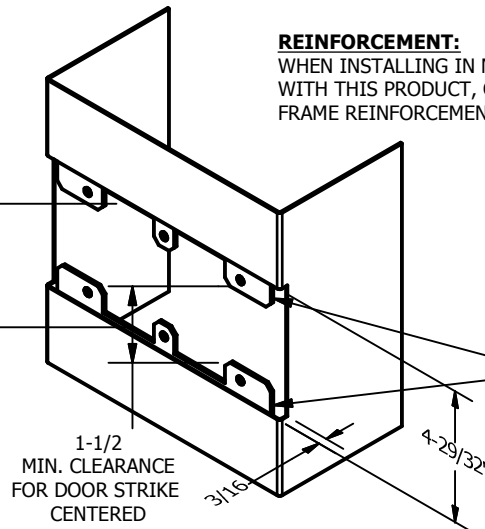

(2) REINFORCEMENT PLATES
 SUPPLIED BY DOOR FRAME
 MANUFACTURER

ORDER #: _____
 ORDER DATE: _____
 CUSTOMER: _____
 CUSTOMER PO#: _____
 MATERIAL: _____
 QUANTITY: _____

**CUT-OUT FOR
 METAL JAMB**

Architectural Builders Hardware Mfg., Inc.

1222 Ardmore Ave., Itasca, IL 60143
 630.875.9900; FAX 800.9FAXABH (932.9224)
 www.abhmfg.com
 Email: abhinfo@abhmfg.com