

SP-CR744 CUSTOM DOUBLE LIPPED STRIKE AND RESCUE STOP

FOR 1-3/4" DOOR, 1/8" INSET, MORTISE LOCK, NO DEADBOLT, 4-1/2" FRAME

**ABH DOOR STOP COVER DIMENSIONS
MAY NOT MATCH OTHER MANUFACTURERS**

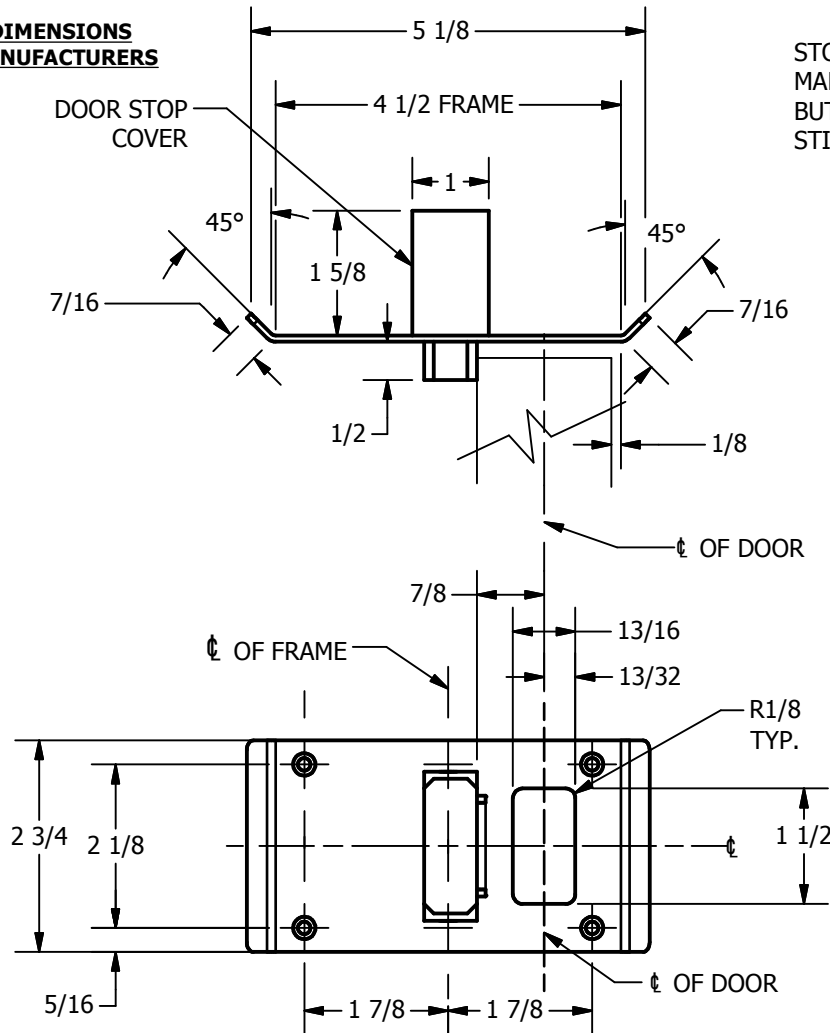

STOP IS SPRING LOADED
MAKING PART NON-HANDED
BUT INSTALLATION IS
STILL HANDED

REINFORCEMENT:

WHEN INSTALLING IN METAL FRAME, REINFORCEMENT IS **NEEDED** WITH THIS PRODUCT, CUSTOMER OR MANUFACTURER TO SUPPLY FRAME REINFORCEMENT WITH LATCH BOLT CLEARANCE

2-5/16
MIN. CLEARANCE
FOR DOOR STOP COVER
CENTERED

1-1/2
MIN. CLEARANCE
FOR DOOR STRIKE
CENTERED

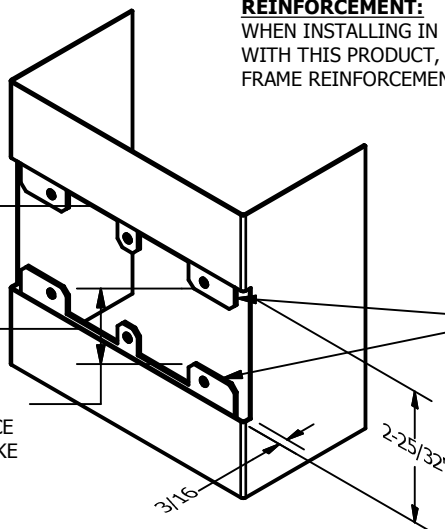

(2) REINFORCEMENT PLATES
SUPPLIED BY DOOR FRAME
MANUFACTURER

NOTE:

1. HORIZONTAL CENTERLINE OF PLATE TO MATCH HORIZONTAL CENTERLINE OF CUTOUT.
2. SCREWS 8-32 X 3/8" UNDERCUT F.H.M.S.
3. R.H. DOOR SHOWN, L.H. OPPOSITE

**CUT-OUT FOR
METAL JAMB**

ORDER #: _____
 ORDER DATE: _____
 CUSTOMER: _____
 CUSTOMER PO#: _____
 MATERIAL: _____
 QUANTITY: _____

Architectural Builders Hardware Mfg., Inc.

1222 Ardmore Ave., Itasca, IL 60143
 630.875.9900; FAX 800.9FAXABH (932.9224)

www.abhmfg.com
 Email: abhinfo@abhmfg.com