

**A260HD - "ES" OPTION, CONCEALED ELECTRIFICATION, FULL CONCEALED,
ALUMINUM GEARED HINGE**

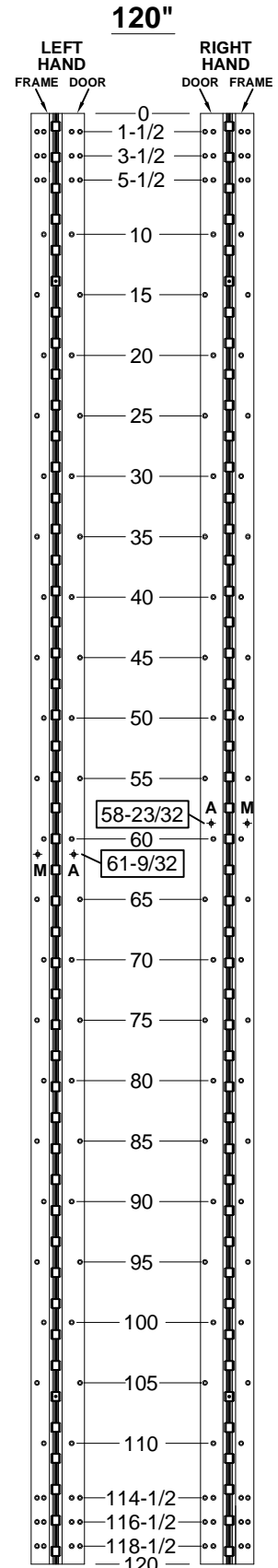

M = MONITOR SWITCH SIDE
A = ADJUSTMENT SCREW SIDE

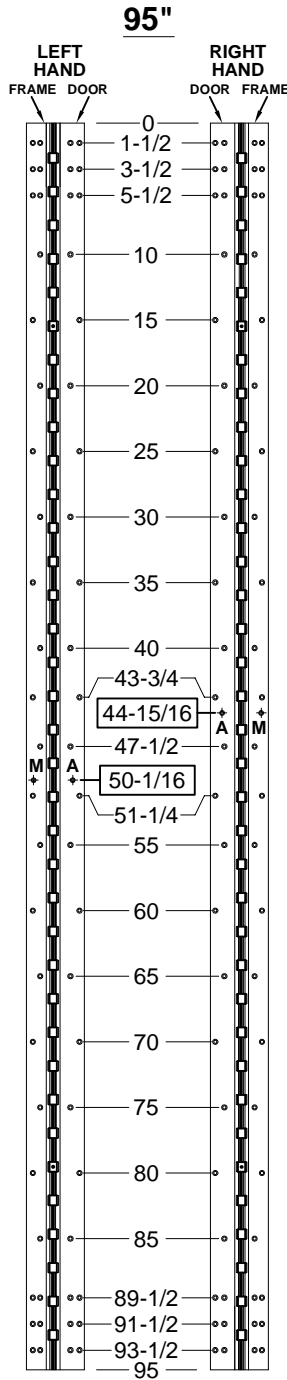
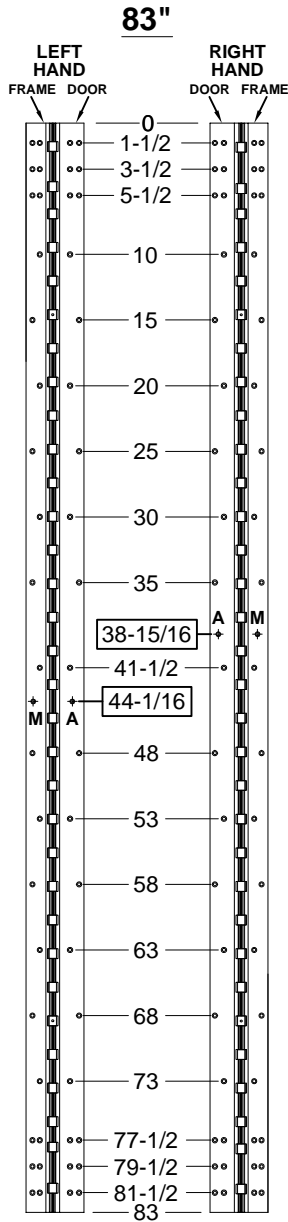

STANDARD HINGE SIZES & SCREW DETAIL

NOMINAL DOOR HEIGHT		7'0"	8'0"	10'0"
ACTUAL HINGE LENGTH		83"	95"	120"
FRAME	12-24 x 7/8" PHILLIPS FLAT HEAD, UNDERCUT, SELF DRILLING, THREAD FORMING TEK MACHINE SCREW	25	29	33
DOOR	12-24 x 7/8" PHILLIPS FLAT HEAD, UNDERCUT, SELF DRILLING, THREAD FORMING TEK MACHINE SCREW	25	29	33



® www.abhmfg.com
E-mail: abhinfo@abhmfg.com
Architectural Builders Hardware Mfg., Inc.
1222 Ardmore Ave., Itasca, IL 60143
630.875.9900; FAX 800.9FAXABH (932.9224)

A260HD-ES OPTION, CONCEALED ELECTRIFICATION-1-00

**A260HD - "ES" OPTION
CONCEALED ELECTRIFICATION**

©2016 ABH Mfg., Inc.
printed in USA

PAGE 1 OF 2
ISSUED 02-12-16

**A260HD - "ES" OPTION, CONCEALED ELECTRIFICATION, FULL CONCEALED,
ALUMINUM GEARED HINGE**

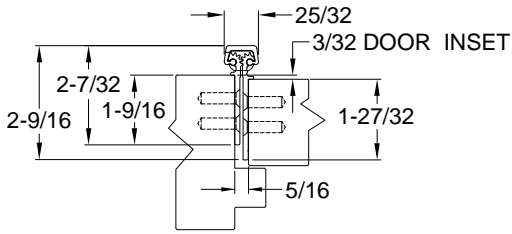

CLOSED POSITION

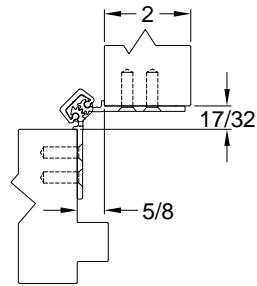

90° OPENING

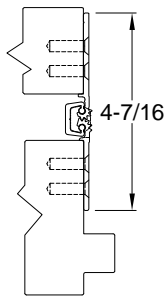

180° OPENING

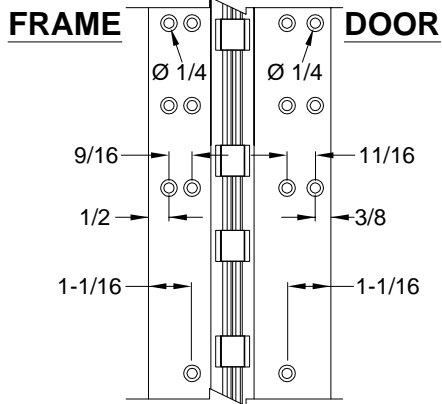
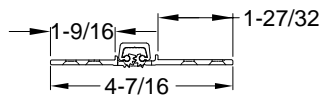

NOTES:

1. HINGES CUT TO CUSTOM LENGTH ARE CUT FROM BOTTOM OF HINGE.
2. SPECIFY HANDING WHEN ORDERING.
3. IF "M" OPTION (MOVEABLE PANEL) OR "R" OPTION (REMOVABLE PANEL) IS CHOSEN, TEMPLATE REMAINS THE SAME.

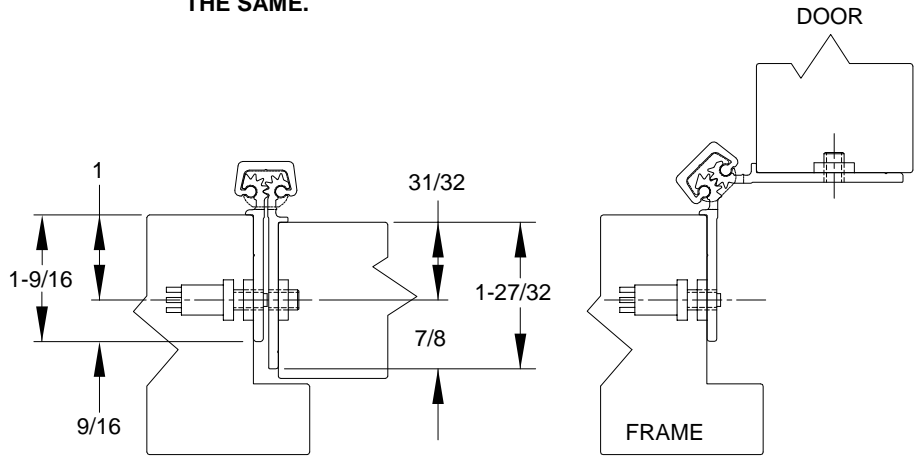

EXPOSED MONITOR SWITCH VIEW, LEFT HAND SHOWN

SWITCH SCHEMATIC

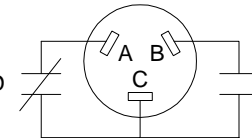

NOTE: 5/8" DIA. HOLE REQUIRED IN JAMB FOR MONITORING SWITCH AND A 7/16" DIA. HOLE FOR CLEARANCE OF ADJUSTMENT SCREW

A & C = NORMALLY CLOSED
B & C = NORMALLY OPEN

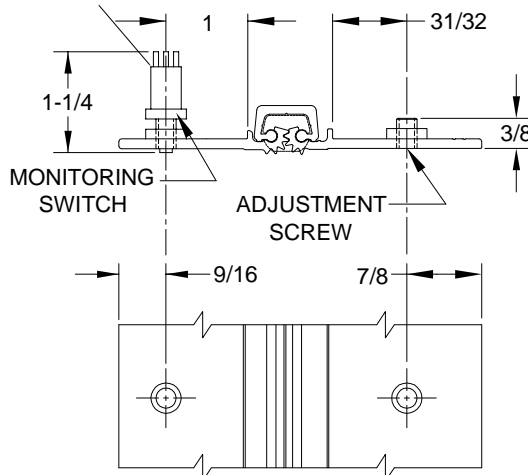

EXPOSED MONITOR SWITCH VIEW



www.abhmfg.com
E-mail: abhinfo@abhmfg.com
Architectural Builders Hardware Mfg., Inc.
1222 Ardmore Ave., Itasca, IL 60143
630.875.9900; FAX 800.9FAXABH (932.9224)

A260HD-ES OPTION, CONCEALED ELECTRIFICATION-2-00

**A260HD - "ES" OPTION
CONCEALED ELECTRIFICATION**

©2016 ABH Mfg., Inc.
printed in USA

PAGE 2 OF 2
ISSUED 02-12-16