

A160HD - "ES" OPTION, CONCEALED ELECTRIFICATION, FULL CONCEALED,  
ALUMINUM GEARED HINGE

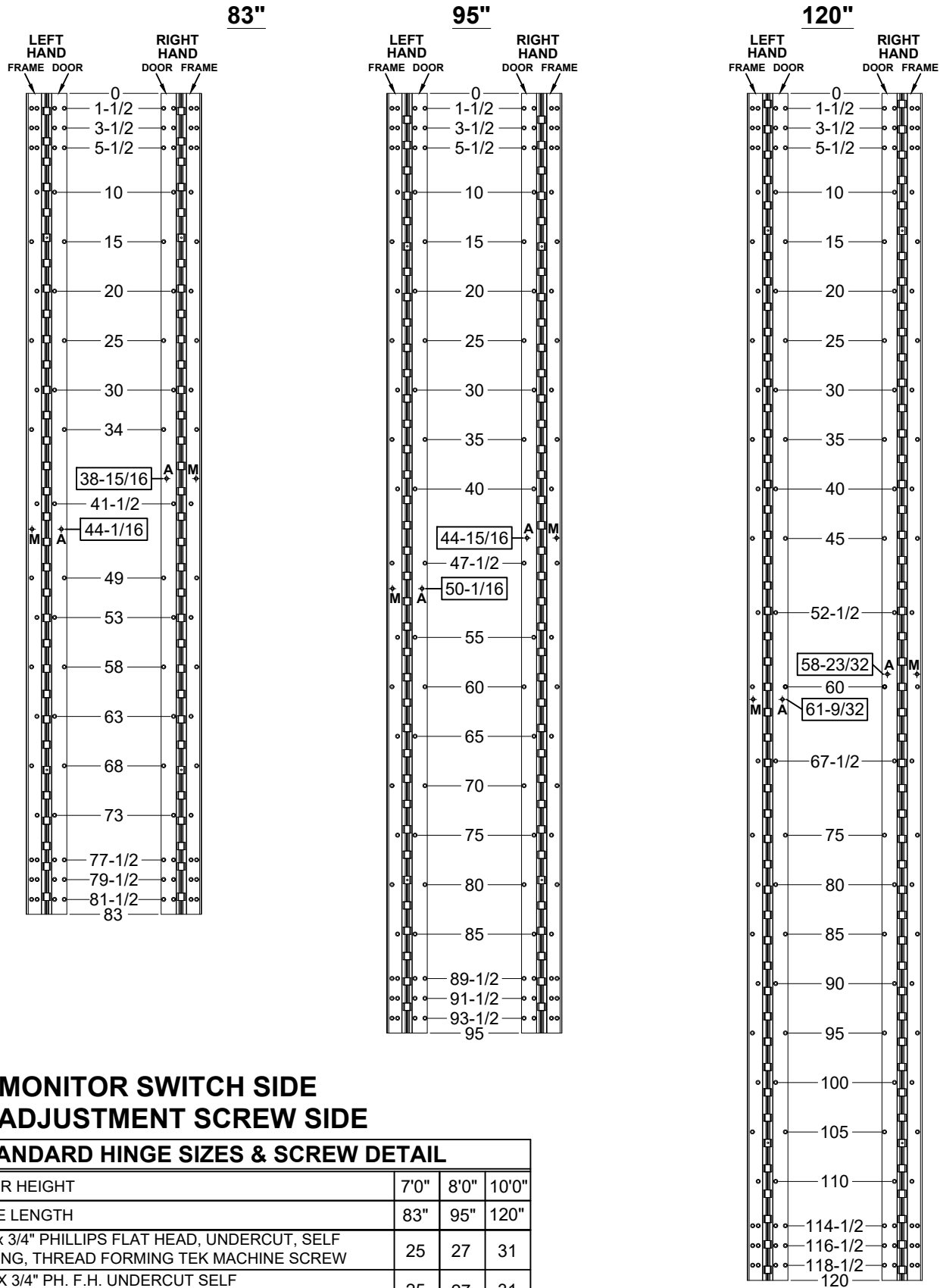

**M = MONITOR SWITCH SIDE**  
**A = ADJUSTMENT SCREW SIDE**

**STANDARD HINGE SIZES & SCREW DETAIL**

		7'0"	8'0"	10'0"
NOMINAL DOOR HEIGHT		7'0"	8'0"	10'0"
ACTUAL HINGE LENGTH		83"	95"	120"
FRAME	12-24 x 3/4" PHILLIPS FLAT HEAD, UNDERCUT, SELF DRILLING, THREAD FORMING TEK MACHINE SCREW	25	27	31
DOOR	12-24 X 3/4" PH. F.H. UNDERCUT SELF DRILLING THREAD FORMING TEK SCREW	25	27	31

A160HD-ES OPTION, CONCEALED ELECTRIFICATION-1-03



www.abhmfg.com  
E-mail: abhinfo@abhmfg.com  
Architectural Builders Hardware Mfg., Inc.  
1222 Ardmore Ave., Itasca, IL 60143  
630.875.9900; FAX 800.9FAXABH (932.9224)

© 2018 ABH Mfg., Inc.  
printed in USA

**A160HD - "ES" OPTION**  
**CONCEALED ELECTRIFICATION**

**A160HD - "ES" OPTION, CONCEALED ELECTRIFICATION, FULL CONCEALED,  
ALUMINUM GEARED HINGE**

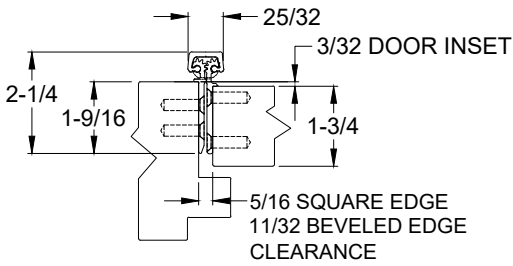

**CLOSED POSITION**

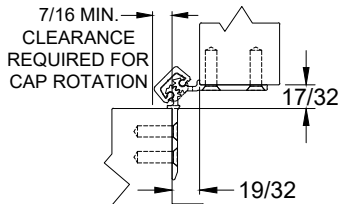

**90° OPENING**

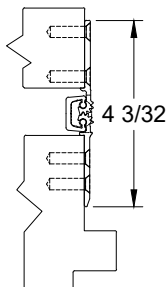

**180° OPENING**

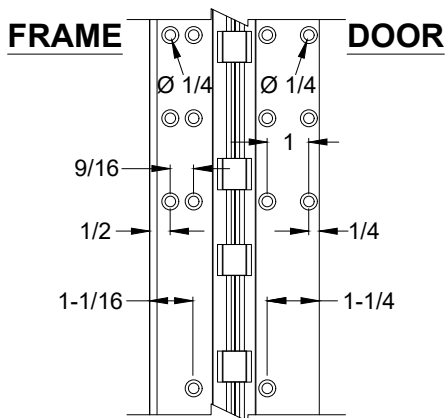
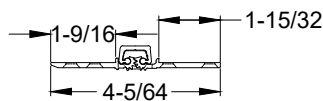

**NOTES:**

1. HINGES CUT TO CUSTOM LENGTH ARE CUT FROM BOTTOM OF HINGE.
2. SPECIFY HANDING WHEN ORDERING.
3. IF "M" OPTION (MOVEABLE PANEL) OR "R" OPTION (REMOVABLE PANEL) IS CHOSEN, TEMPLATE REMAINS THE SAME.

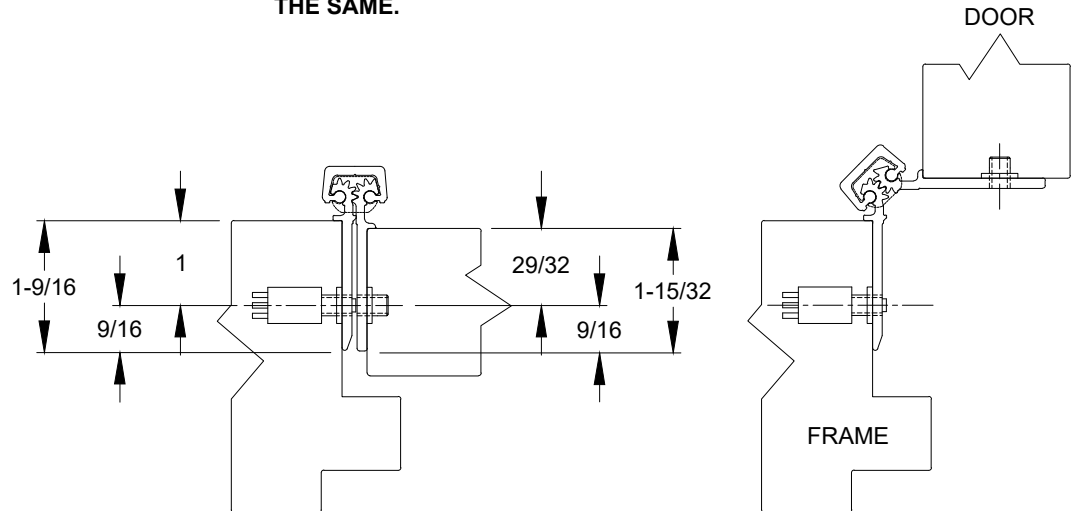

**EXPOSED MONITOR SWITCH VIEW, LEFT HAND SHOWN**

**SWITCH SCHEMATIC**

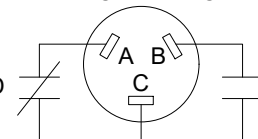

NOTE: 5/8" DIA. HOLE REQUIRED IN JAMB FOR MONITORING SWITCH AND A 7/16" DIA. HOLE FOR CLEARANCE OF ADJUSTMENT SCREW

A & C = NORMALLY CLOSED  
B & C = NORMALLY OPEN

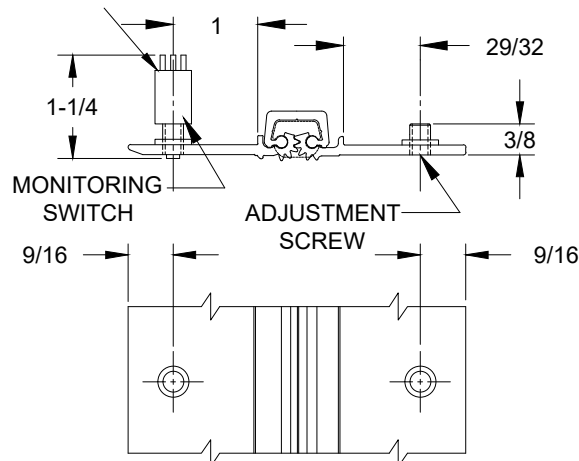

**EXPOSED MONITOR SWITCH VIEW**