

6800 LOW PROFILE PUSH/PULL LATCH METAL DOOR AND FRAME

METAL DOOR NOTES

1. ALL DIMENSIONS MARKED WITH (*) MAY BE $+1/32"$ -0.
2. (**) ADA RECOMMENDED UNLESS OTHERWISE DIRECTED.
-OR-
CHECK LOCAL ORDINANCE FOR PROPER HEIGHT.
3. REINFORCEMENT MUST BE APPLIED ON METAL DOORS AT THE SCREW LOCATIONS.

DOOR LATCH PROVISIONS

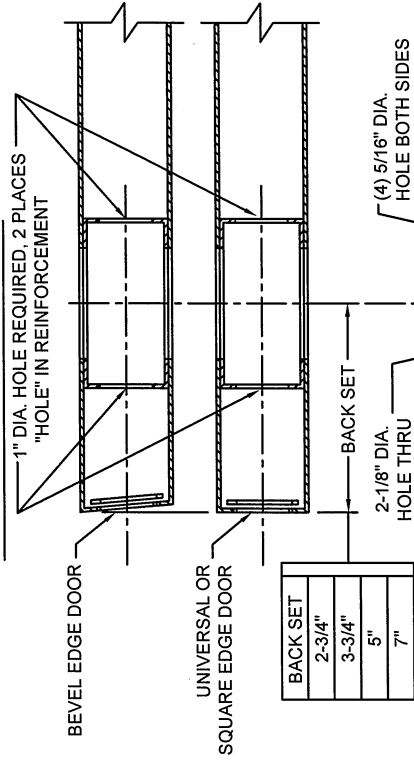

HOLLOW METAL FRAME STRIKE PROVISIONS

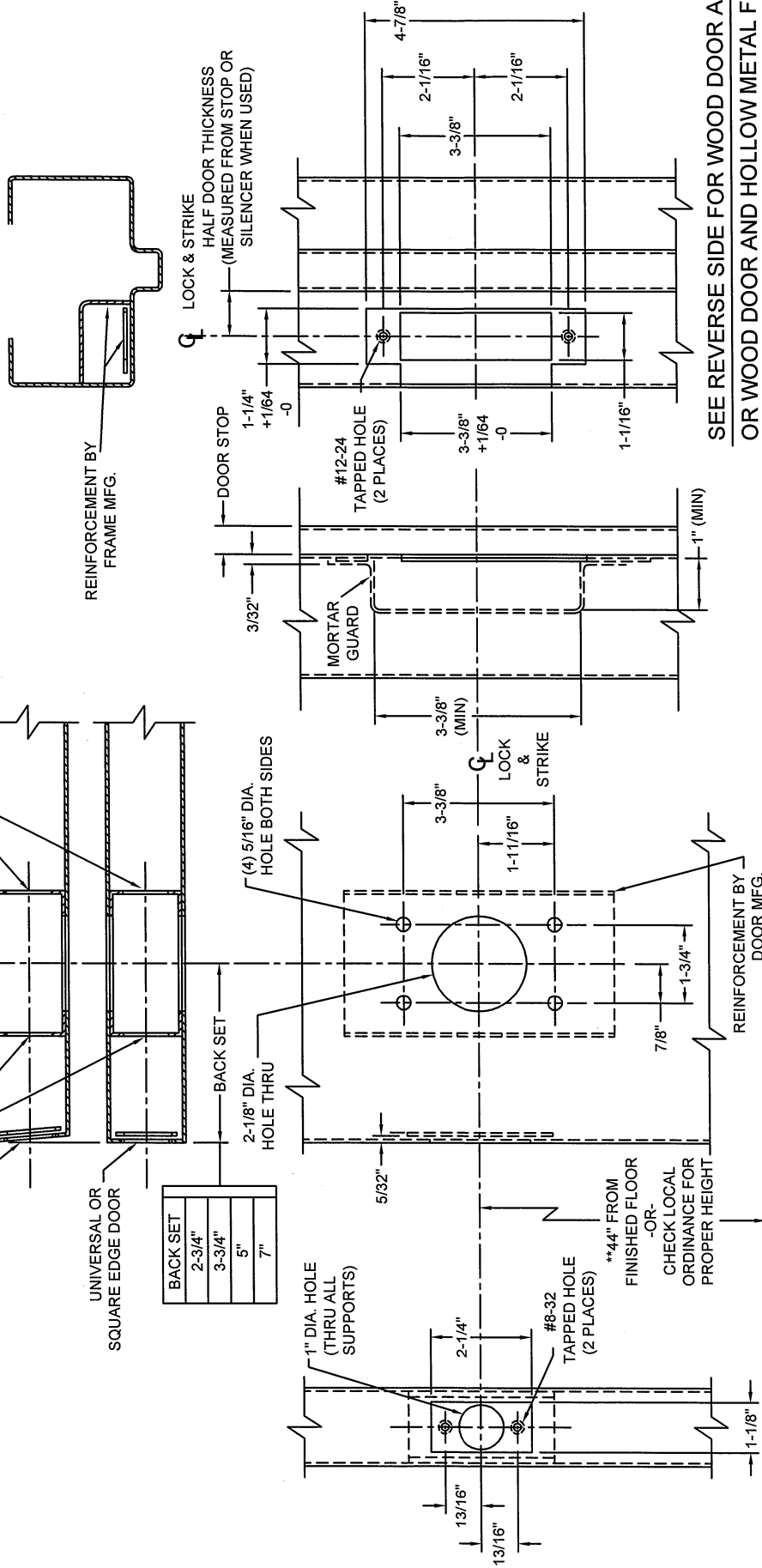

SEE REVERSE SIDE FOR WOOD DOOR AND FRAME
OR WOOD DOOR AND HOLLOW METAL FRAME

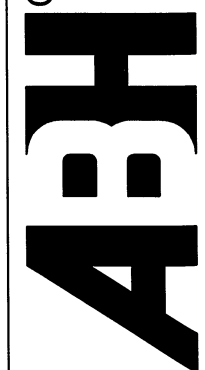

www.abhmfg.com

E-mail: abhinfo@abhmfg.com

Architectural Builders Hardware Mfg., Inc.

1222 Ardmore Ave., Itasca, IL 60143

630.875.9900; FAX 800.9FAXABH (932.9224)

6800-1-02.DWG

6800-1

REVISED 11-03-10

© 2010 ABH Mfg., Inc.
printed in USA

6800 LOW PROFILE PUSH/PULL LATCH

INSTALLATION INSTRUCTIONS WOOD DOOR AND FRAME PREPARATION

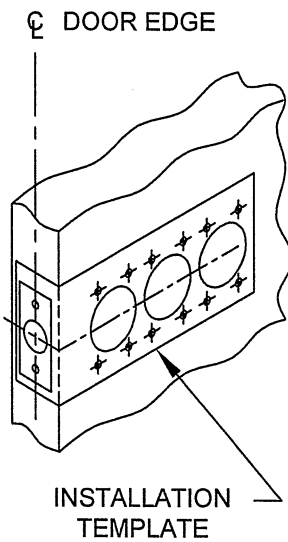
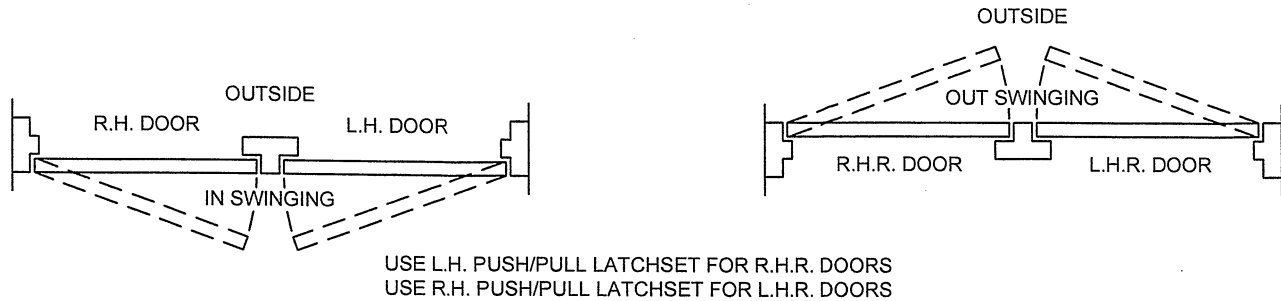

INSTALLATION
TEMPLATE

FIGURE 1

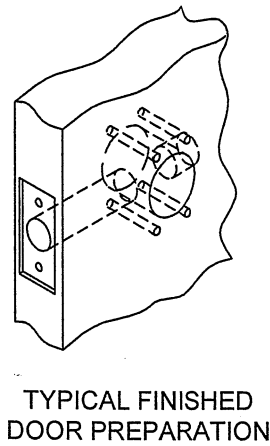

TYPICAL FINISHED
DOOR PREPARATION

FIGURE 2

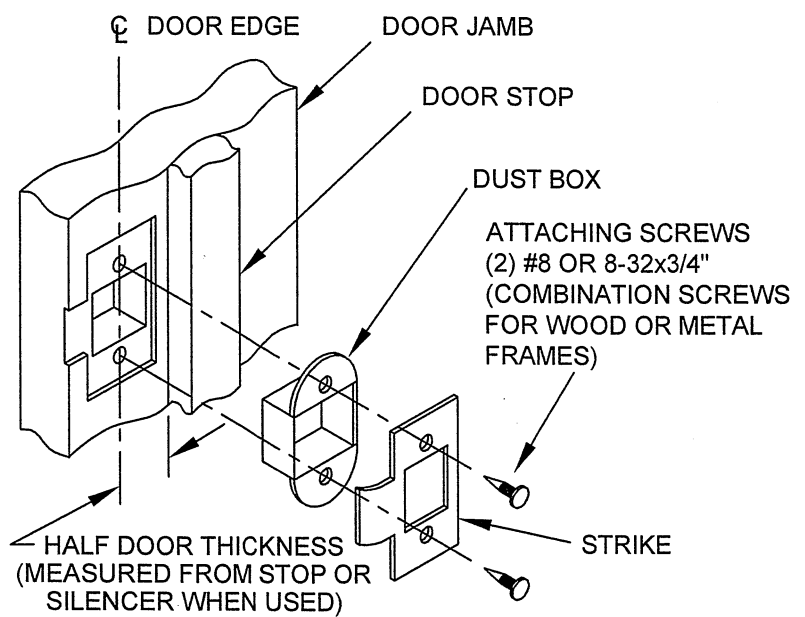

FIGURE 3

MARK THE DOOR AND FRAME.

- A. USING A SQUARE, DRAW A HORIZONTAL LINE ON EDGE AND SURFACE OF DOOR AT 44" (ADA RECOMMENDED UNLESS OTHERWISE DIRECTED) ABOVE THE FLOOR. -OR- CHECK LOCAL ORDINANCE FOR PROPER HEIGHT. ALSO MARK DOOR FRAME AT THIS SAME HEIGHT.
- B. USING INSTALLATION TEMPLATE, MARK LOCATION OF CROSS BORE. ALSO MARK LOCATION OF FOUR (4) 5/16" DIA. THRU HOLES. NEXT MARK EDGE OF DOOR ON VERTICAL CENTERLINE FOR 1" DIA. HOLE (SEE FIGURE 1).
- C. TO DETERMINE LOCATION OF VERTICAL CENTERLINE OF STRIKE, TAKE HALF OF THE DOOR THICKNESS (MEASURED FROM DOOR STOP OR SILENCER IF USED). USING STRIKE AS A TEMPLATE, MARK OUTLINE. ALSO MARK LOCATION OF TWO (2) ATTACHING SCREWS. (SEE FIGURE 3).

MORTISE AND DRILL DOOR AND FRAME.

- A. DRILL HOLES AS DIRECTED ON INSTALLATION TEMPLATE MAKING CERTAIN DRILL IS PERPENDICULAR TO THE DOOR AT ALL TIMES WHILE DRILLING. DRILL 2-1/8" DIA. CROSS BORE FIRST. NEXT, DRILL FOUR (4) 5/16" DIA. MOUNTING HOLES THRU. THEN DRILL 1" DIA. EDGE HOLE.
- B. INSERT LATCH BOLT UNIT INTO HOLE IN EDGE OF DOOR. USING FACE PLATE AS A TEMPLATE, MARK OUTLINE. ALSO MARK LOCATION OF TWO (2) ATTACHING SCREWS. REMOVE LATCH BOLT UNIT.
- C. DRILL PILOT HOLES FOR TWO (2) ATTACHING SCREWS. NEXT, MORTISE DOOR EDGE 5/32" DEEP FOR FACE PLATE (SEE FIGURE 2).
- D. DRILL PILOT HOLES FOR STRIKE SCREWS IN DOOR JAMB. MORTISE JAMB 3/32" DEEP FOR STRIKE. MORTISE JAMB TO RECEIVE STRIKE BOX. (SEE FIGURE 3).



® www.abhmf.com
E-mail: abhinfo@abhmf.com
Architectural Builders Hardware Mfg., Inc.
1222 Ardmore Ave., Itasca, IL 60143
630.875.9900; FAX 800.9FAXABH (932.9224)

© 2010 ABH Mfg., Inc.
printed in USA

6800-3

REVISED 11-03-10

6800-3-02.DWG

6800 LOW PROFILE PUSH/PULL LATCH

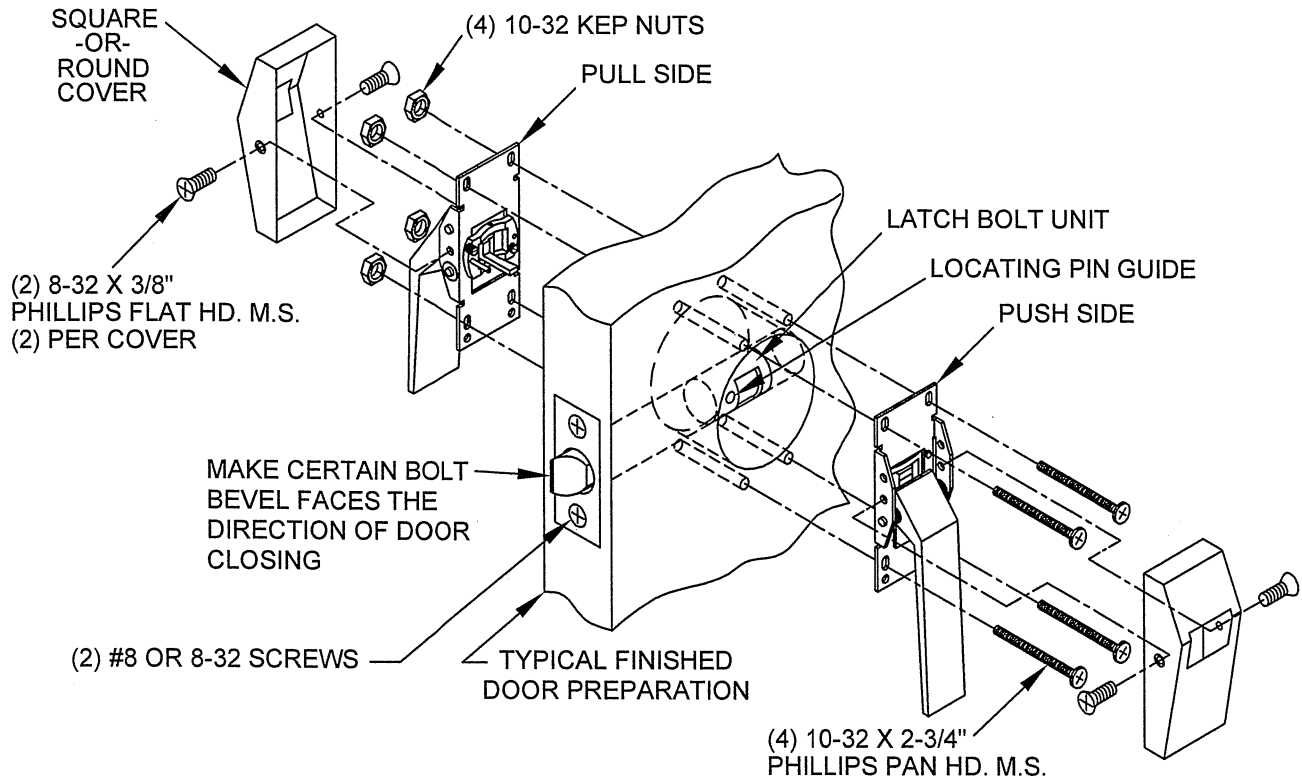

INSTALLATION INSTRUCTIONS

1. PUSH/PULL LATCHES ARE ASSEMBLED FOR RIGHT HAND AND LEFT HAND DOORS. BE SURE CORRECT SIDE MATCHES DOOR APPLICATION.
2. PLACE LATCH BOLT UNIT IN DOOR MAKING SURE BOLT BEVEL FACES DIRECTION OF DOOR CLOSING. ATTACH FRONT WITH TWO (2) #8 OR 8-32 SCREWS DEPENDING ON DOOR.
3. POSITION LEVER ASSEMBLIES SO THAT LOCATING PIN AND CAM ARM ENTER INTO CORRESPONDING HOLES IN LATCH BOLT UNIT. ATTACH LEVER ASSEMBLIES BY THRU BOLTING ONTO DOOR WITH FOUR (4) #10-32 X 2-3/4" PHILLIPS PAN HD. M.S. AND FOUR (4) #10-32 KEP NUTS. FOR PURPOSE OF ALIGNMENT DO NOT TIGHTEN SCREWS UNTIL ALL FOUR (4) SCREWS HAVE BEEN STARTED.
4. APPLY COVERS AND FASTEN WITH (2) 8-32 X 3/8" FLAT HD. M.S. FOR EACH COVER.
5. INSERT DUST BOX IN MORTISE AND ATTACH STRIKE WITH TWO (2) #8-8-32 SCREWS.

TO CHANGE DIRECTION OF PUSH OR PULL HANDLE

NOTE: REVERSE INSTALLATION INSTRUCTIONS #4 & # 3 THEN CONTINUE WITH INSTRUCTIONS 1, 2 & 3 BELOW.

1. REMOVE THE (2) 10-32 SHOULDER BOLTS WITH SPRINGS THAT SECURE THE CAM HOLDER ASSEMBLY, NOTE THE DIRECTION OF THE LOCATING PIN BEFORE STARTING.
2. ROTATE THE CAM HOLDER ASSEMBLY 180°.
3. REINSTALL THE (2) 10-32 SHOULDER BOLTS WITH SPRINGS.

10-32 SHOULDER BOLTS WITH SPRINGS

CAM HOLDER

LOCATING PIN

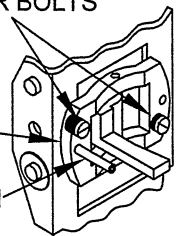

PATENT PENDING



® www.abhmfg.com
 E-mail: abhinfo@abhmfg.com
 Architectural Builders Hardware Mfg., Inc.
 1222 Ardmore Ave., Itasca, IL 60143
 630.875.9900; FAX 800.9FAXABH (932.9224)

© 2010 ABH Mfg., Inc.
 printed in USA

6800-4

REVISED 11-03-10

6800-4-02.DWG