

CUSTOM DOUBLE LIPPED RESCUE STOP ORDER FORM

ORDER DATE: _____

CUSTOMER NAME: _____

CUSTOMER P.O. No.: _____

ABH SALES ORDER No.: _____

MATERIAL: _____ QUANTITY: _____

CUSTOMER SIGNATURE: _____ DATE: _____

NOTE: ALL CUSTOM RESCUE STRIKES ARE NONRETURNABLE.

CUSTOM DOUBLE LIPPED RESCUE STOP FOR 1-3/4 THICK CENTER HUNG DOOR

STOP IS SPRING LOADED
MAKING PART NON-HANDED
BUT INSTALLATION IS
STILL HANDED

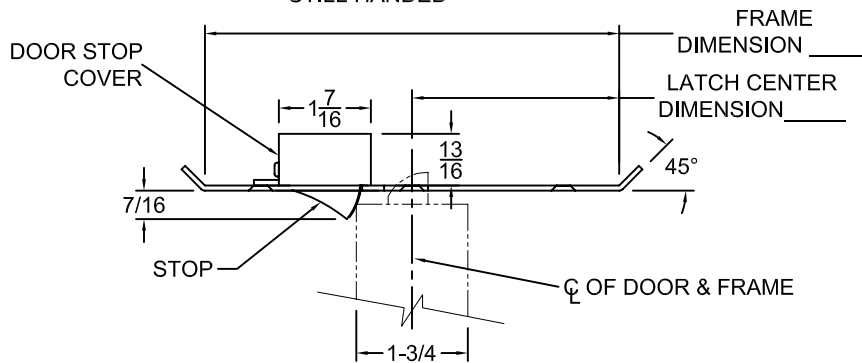

TOP VIEW

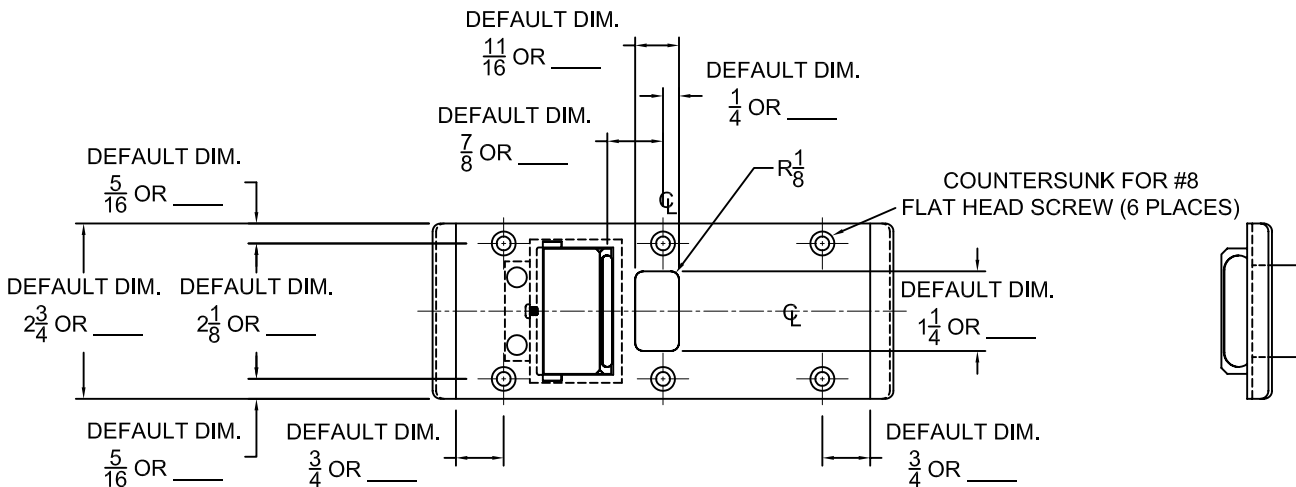

FRONT VIEW

SIDE VIEW

NOTE:

1. FRAME REINFORCEMENT SUPPLIED BY OTHERS.
2. FOR CUSTOM OPTION DIMENSION NOT SHOWN CONSULT FACTORY.



www.abhmfg.com
 E-mail: abhinfo@abhmfg.com
 Architectural Builders Hardware Mfg., Inc.
 1222 Ardmore Ave., Itasca, IL 60143
 630.875.9900; FAX 800.9FAXABH (932.9224)

CUSTOM CR4590 DOUBLE LIPPED RESCUE
 STOP CENTER HUNG ORDER FORM

© 2007 ABH Mfg., Inc.
 printed in USA

REVISED 11-01-07